

HA13127, HA13130

17 W Dual BTL Audio Power Amplifier

The HA13127/HA13130 are high output and low distortion dual BTL power IC designed for car stereo amplifiers.

At 14.4 V to 4 Ω load, this power IC provides an output power 17 W with 10 % distortion.

Features

- Stand-by circuit included.
Can be switched on & off easily by microcomputer.
- Output capacitors not required.
These IC employ internal ASO protection circuit of high reliability current shutdown type, which can protect speaker.
- Surge protection circuit and thermal shutdown circuit are included.
Thermal shutdown is high speed and hysteresis on & off type.
- Can be used without bootstrap capacitor.
- Low total harmonic distortion in wide frequency range
THD = 0.05 % Typ ($f = 50$ Hz)
THD = 0.05 % Typ ($f = 1$ kHz)
THD = 0.07 % Typ ($f = 10$ kHz)
THD = 0.1 % or less
($P_{out} = 1.5$ W, $f = 20$ Hz to 20 kHz)

Ordering Information

Type No.	Voltage gain	Package
HA13127	50 dB	16 pin SIP with heat sink
HA13130	40 dB	



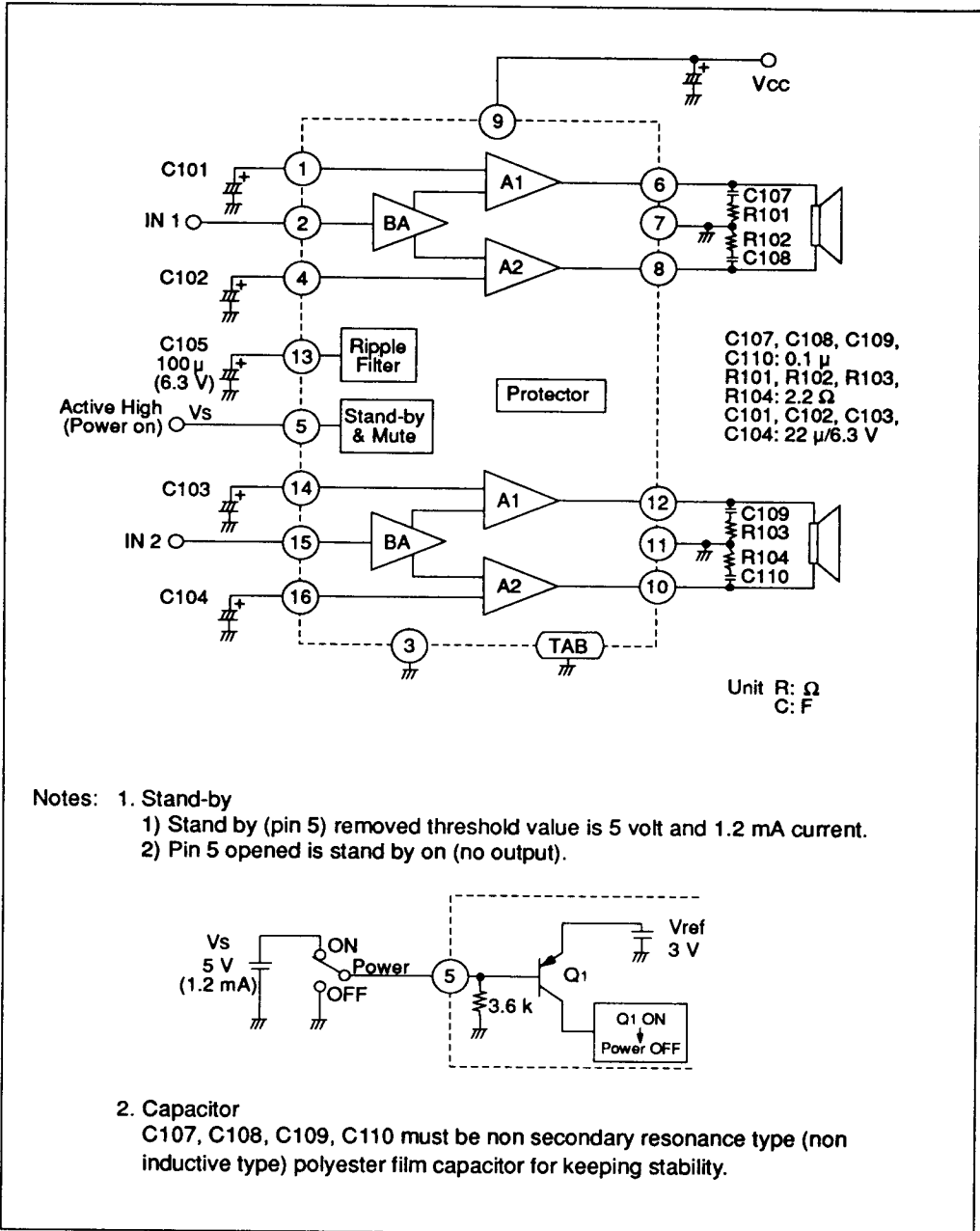

Figure 1 Block Diagram



HA13127, HA13130

Absolute Maximum Ratings (Ta = 25 °C)

Item	Symbol	Rating	Unit	Notes
Operating supply voltage	Vcc	18	V	
DC supply voltage	Vcc (DC)	26	V	1
Peak supply voltage	Vcc (Peak)	50	V	2
Output current	Io (peak)	4	A	Per channel
Power dissipation	Pr	25	W	
Junction temperature	Tj	150	°C	
Operating temperature	Topr	-30 to +85	°C	
Storage temperature	Tstg	-55 to +125	°C	

Notes: 1. Value at $t \leq 30$ sec

2. Value at surge wave-form (rise time $t \geq 1$ ms)

Electrical Characteristics (Vcc = 13.2 V, f = 1 kHz, RL = 4 Ω, dual operation, Ta = 25 °C)

HA13127 (Gv = 50 dB) HA13130 (Gv = 40 dB)

Item	Symbol	HA13127 (Gv = 50 dB)			HA13130 (Gv = 40 dB)			Unit	Test Conditions
		Min	Typ	Max	Min	Typ	Max		
Quiescent current	Iq1	60	150	250	60	150	250	mA	Vin = 0 V
Input bias voltage	Vb	—	20	40	—	20	40	mV	Vin = 0 V
Output offset voltage	ΔVo	—	0	150	—	0	150	mV	Vin = 0 V
Voltage gain	Gv	48.5	50	51.5	38.5	40	41.5	dB	
Difference of voltage gain	ΔGv	—	—	1.5	—	—	1.5	dB	
Output power (1)	Po1	10	14	—	10	14	—	W	Vcc = 13.2 V THD = 10 %
Output power (2)	Po2	—	17	—	—	17	—	W	Vcc = 14.4 V THD = 10 %
Output power (3)	Po3	—	6	—	—	11	—	W	Vcc = 13.2 V THD = 1 %
Total harmonic distortion	THD	—	0.2	0.7	—	0.04	0.15	%	Pout = 1.5 W



Electrical Characteristics ($V_{CC} = 13.2\text{ V}$, $f = 1\text{ kHz}$, $R_L = 4\ \Omega$, dual operation, $T_a = 25\ ^\circ\text{C}$) (cont)

Noise output (1)	WBN ₁	—	1.0	2.0	—	0.35	0.7	mV	$R_g = 10\text{ k}\Omega$ BW = 20 Hz to 20 kHz
Noise output (2)	WBN ₂	—	0.8	1.7	—	0.25	0.5	mV	$R_g = 0$ BW = 20 Hz to 20 kHz
Supply voltage rejection ratio	SVR	32	40	—	45	60	—	dB	$f = 500\text{ Hz}$, Vripple = 0 dBm
Low roll-off Frequency	$f_{L\alpha}$	—	20	—	—	10	—	Hz	$\Delta G_v = -3\text{ dB}$ from
High roll-off frequency	$f_{H\alpha}$	—	20	—	30	70	140	kHz	$f = 1\text{ kHz}$
Stand-by current	I_{OZ}	—	50	200	—	50	200	μA	V 5 Open
Stand-by threshold voltage	$V_{TH(H)}$	5	—	$V_{CC}-1$	5	—	$V_{CC}-1$	V	$V_{in} = 50\text{ dBm}$ Output on
	$V_{TH(L)}$	0	—	1	0	—	1	V	Output off
Stand-by (Mute) signal reduction level	ATT	45	60	—	45	60	—	dB	$V_{in} = -50\text{ dBm}$
Stand-by (Mute) on time	t_F	—	10	—	—	10	—	μs	$V_1 = 3\text{ V}$ to Open (Power on to off)
Stand-by (Mute) off time	t_R	—	0.2	—	—	0.2	—	sec	$V_1 = \text{Open}$ to 3 V (Power off to on)
Input impedance	R_{in}	20	30	40	20	30	40	$\text{k}\Omega$	
Channel cross-talk	CT	—	60	—	45	60	—	dB	$V_{out} = 0\text{ dBm}$
Output power (4)	P_{O4}	—	10	—	—	10	—	W	THD = 10 % $R_L = 8\ \Omega$
Output power (5)	P_{O5}	—	7	—	—	7	—	W	THD = 1 % $R_L = 8\ \Omega$



Output power vs. supply voltage (1)

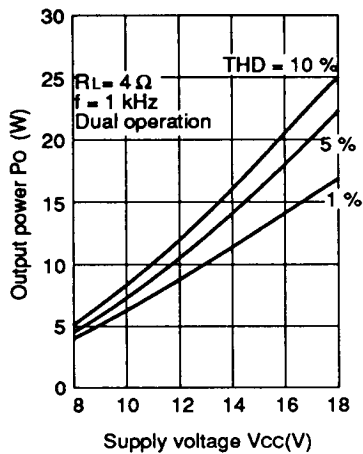

Output power vs. supply voltage (2)

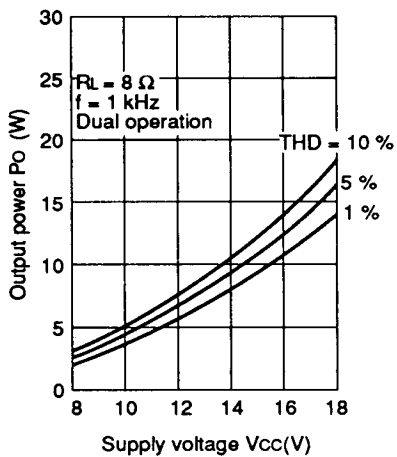

Figure 2 HA13130 Characteristic Curves



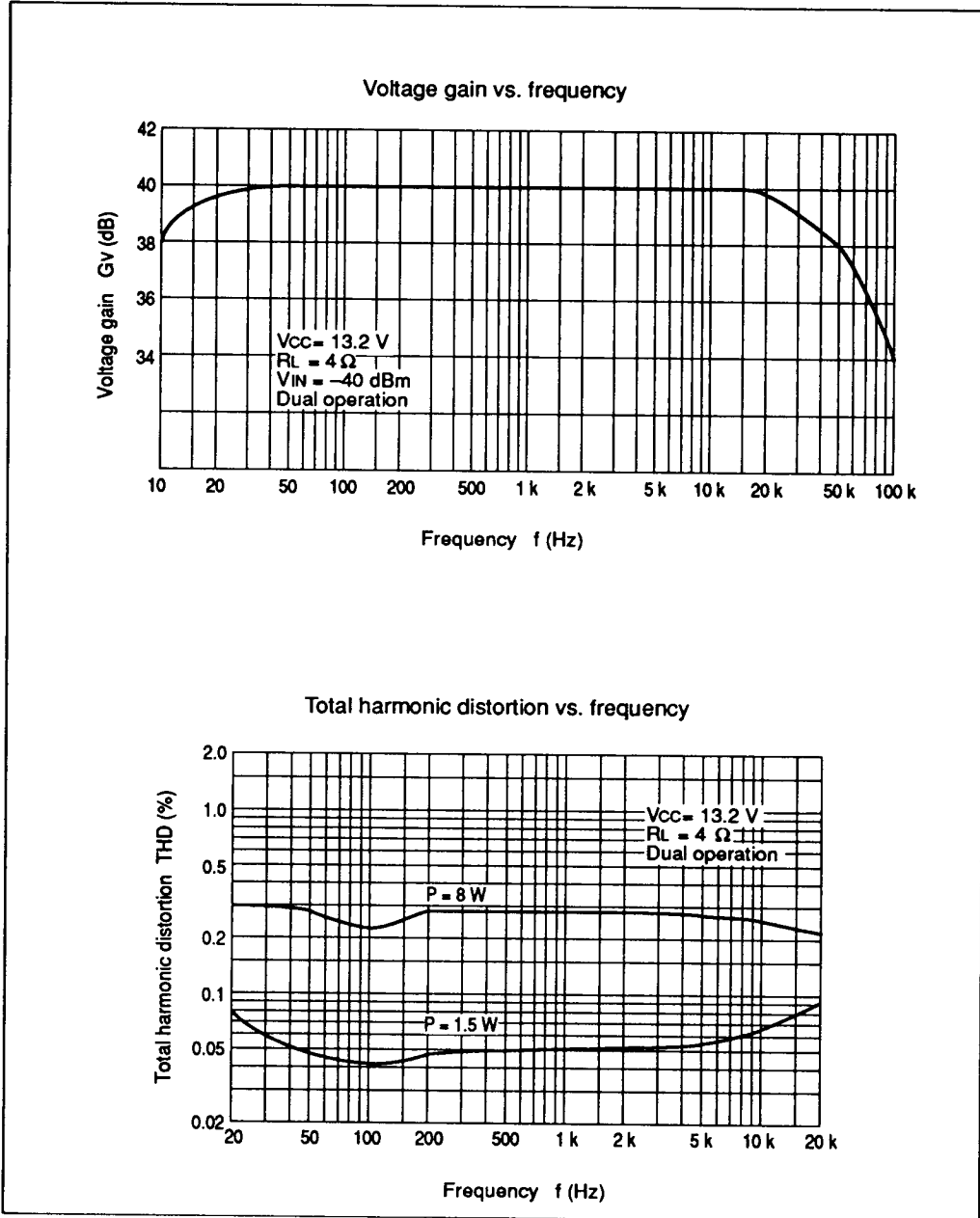

Figure 2 HA13130 Characteristic Curves (cont)



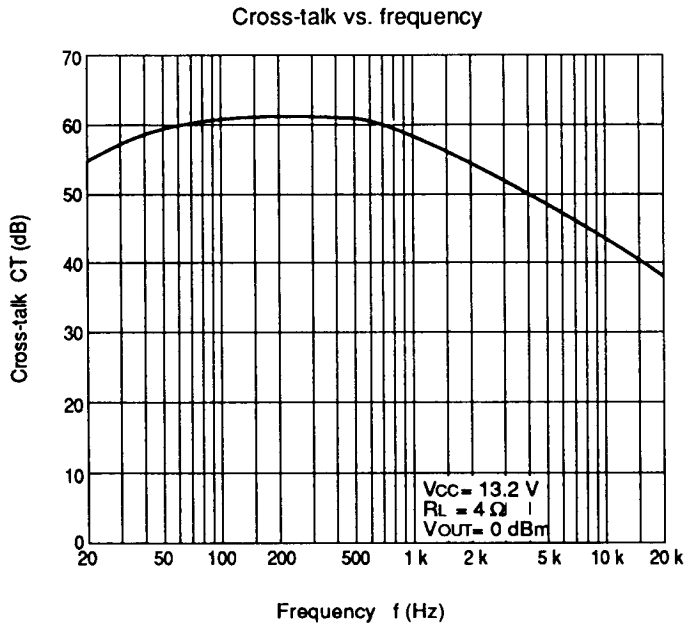
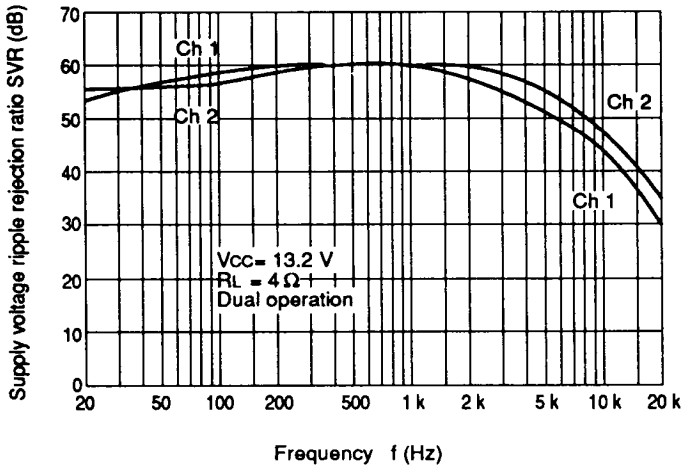
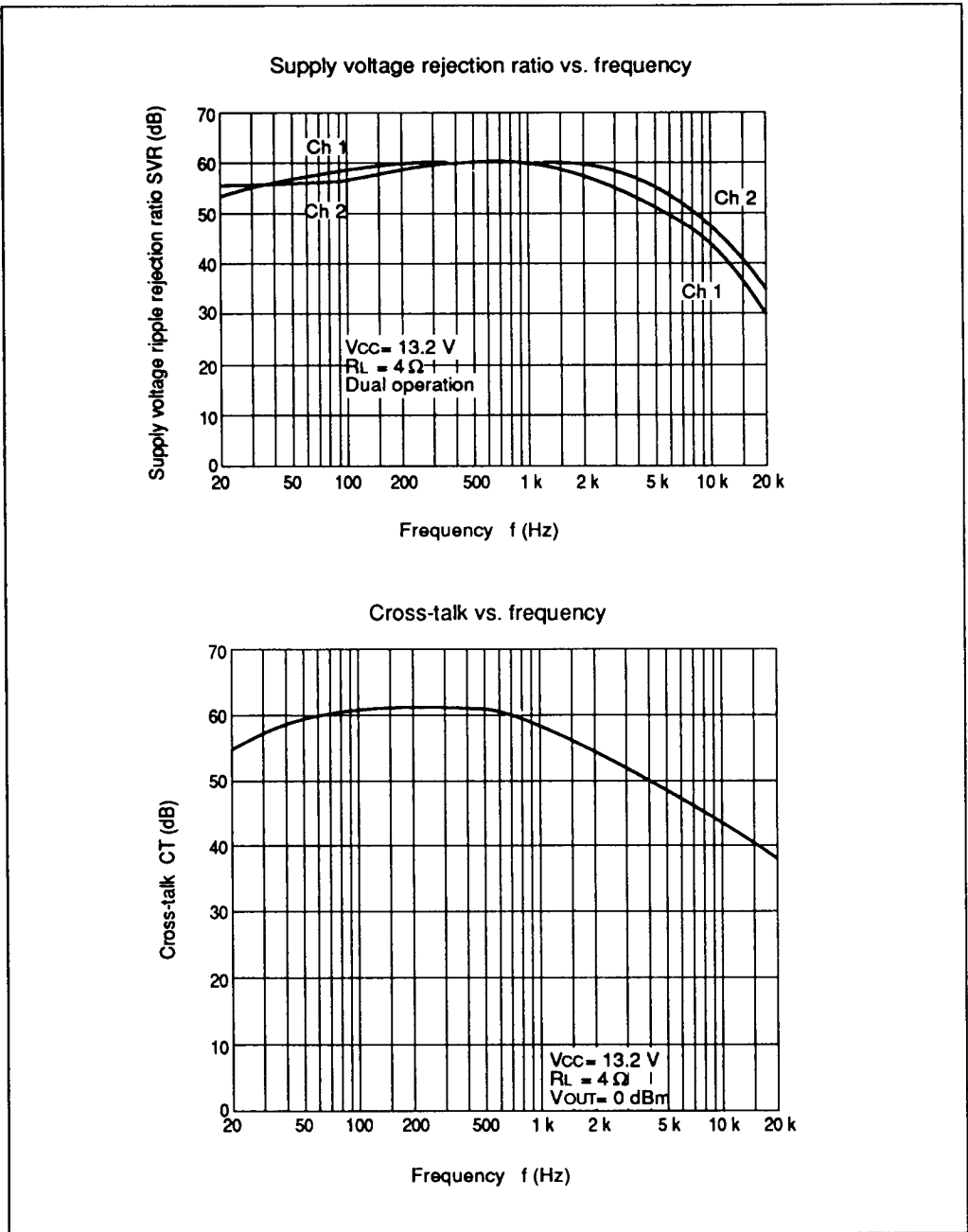

Figure 2 HA13130 Characteristic Curves (cont)



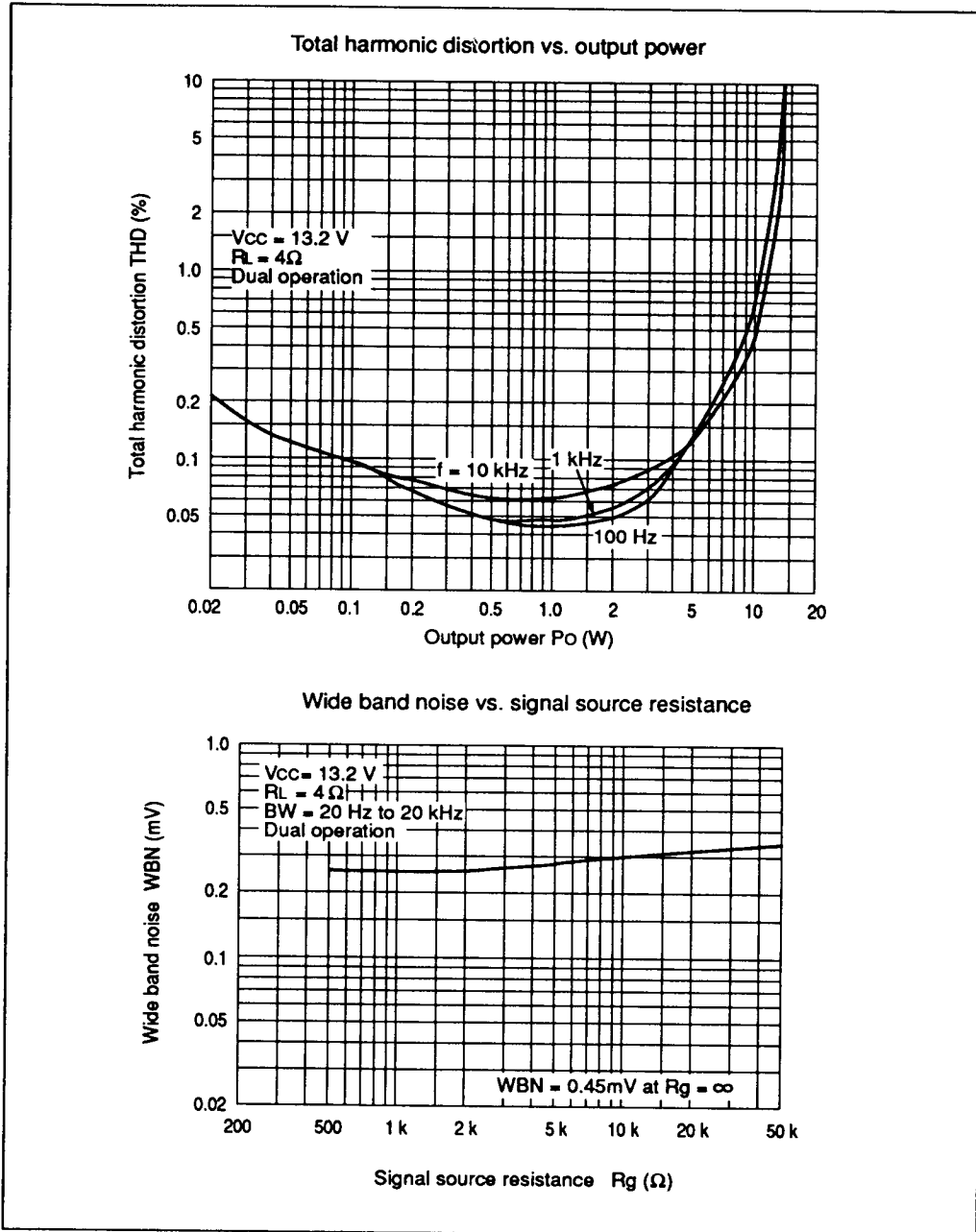

Figure 2 HA13130 Characteristic Curves (cont)



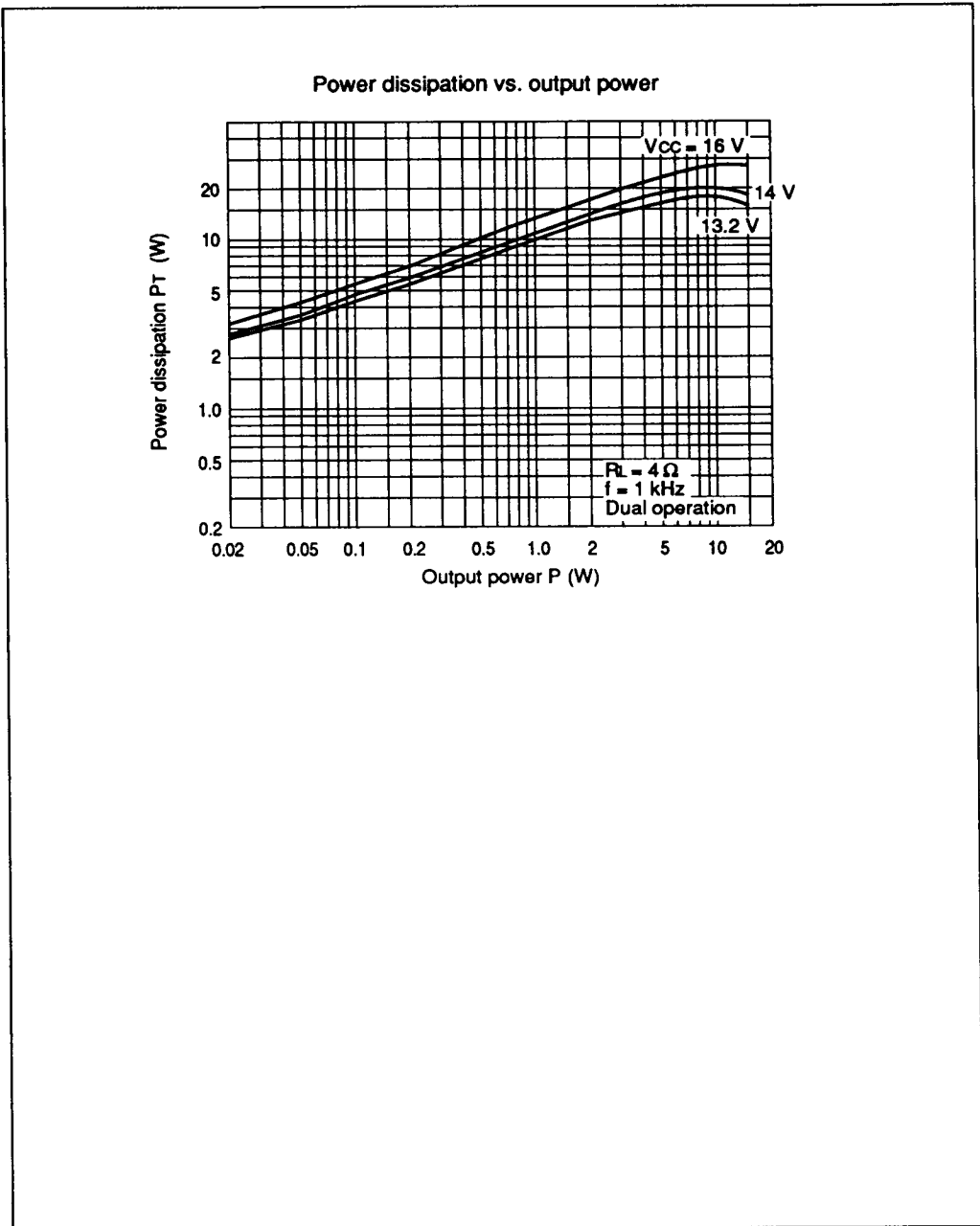
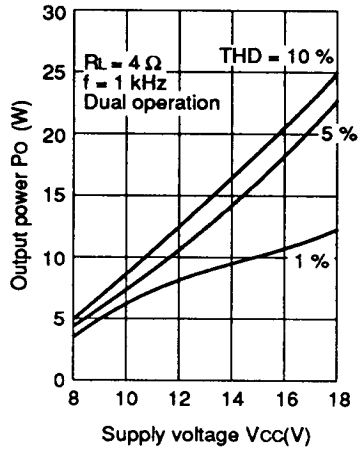

Figure 2 HA13130 Characteristic Curves (cont)



Power dissipation vs. output power (1)



Power dissipation vs. output power (2)

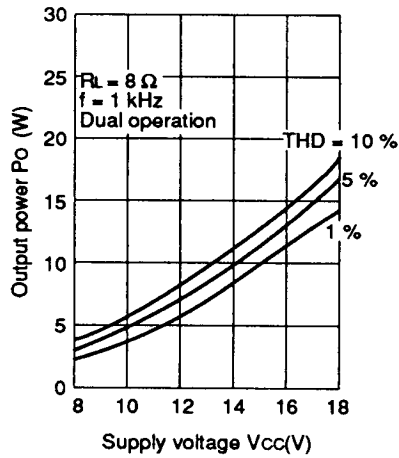

Figure 3 HA13127 Characteristic Curves



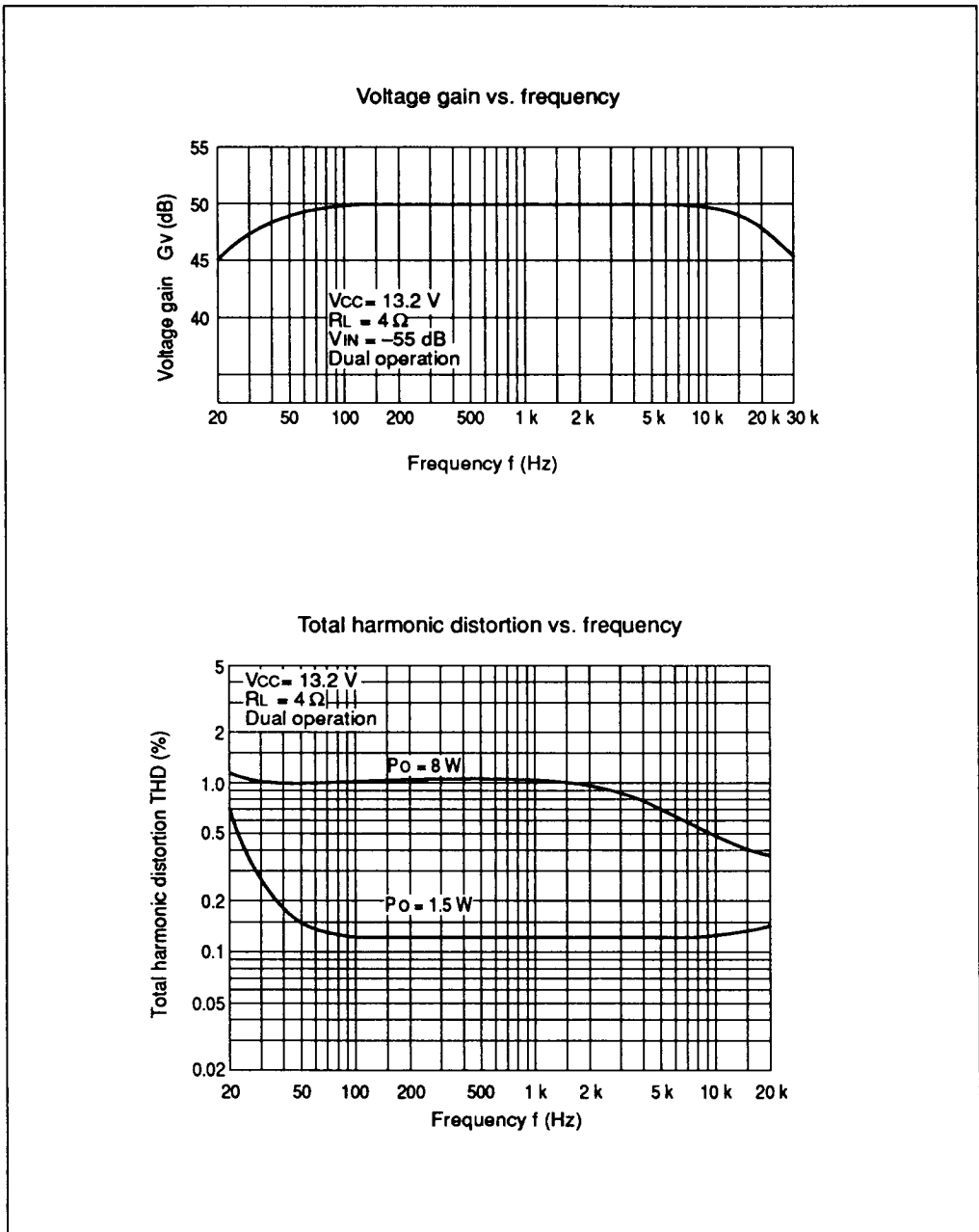

Figure 3 HA13127 Characteristic Curves (cont)



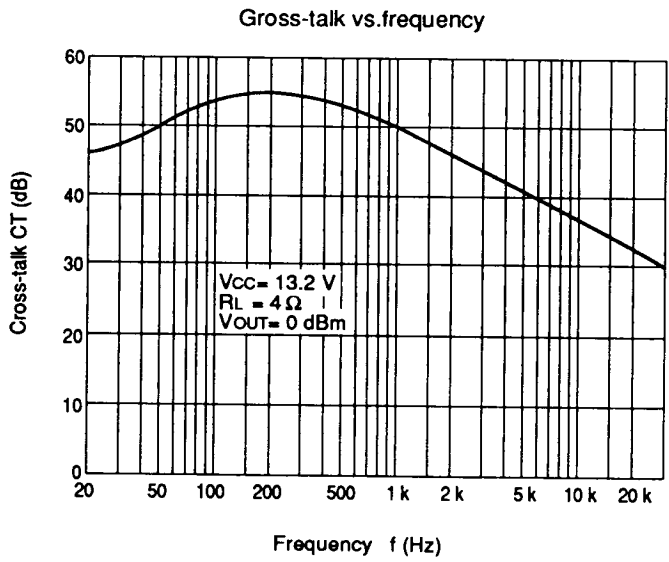
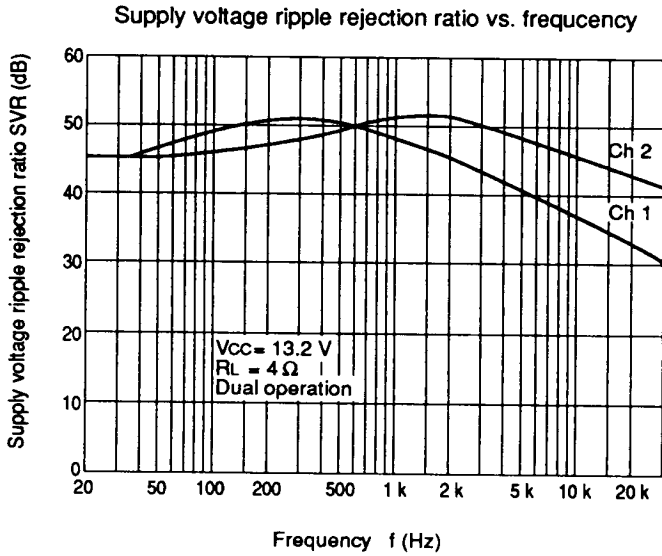

Figure 3 HA13127 Characteristic Curves (cont)



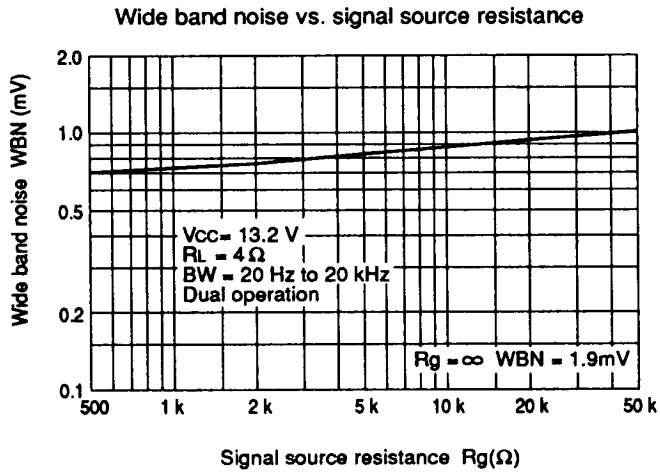
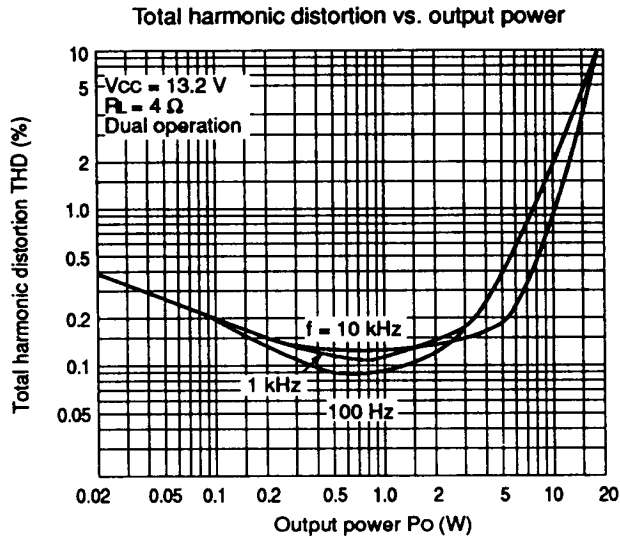

Figure 3 HA13127 Characteristic Curves (cont)

