

IR2121

CURRENT LIMITING LOW SIDE DRIVER

Features

- Gate drive supply range from 12 to 18V
- Undervoltage lockout
- Current detection and limiting loop to limit driven power transistor current
- Error lead indicates fault conditions and programs shutdown time
- Output in phase with input

Description

The IR2121 is a high speed power MOSFET and IGBT driver with over-current limiting protection circuitry. Latch immune CMOS technology enables ruggedized monolithic construction. Logic inputs are compatible with standard CMOS or LSTTL outputs. The output driver features a high pulse current buffer stage designed for minimum cross-conduction. The protection circuitry detects over-current in the driven power transistor and limits the gate drive voltage. Cycle-by-cycle shutdown is programmed by an external capacitor which directly controls the time interval between detection of the over-current limiting condition and latched shutdown. The output can be used to drive an N-channel power MOSFET or IGBT in the low side configuration.

Product Summary

V_{OFFSET}	5V max.
$I_{\text{O+/-}}$	1A / 2A
V_{OUT}	12 - 18V
V_{Csth}	230 mV
$t_{\text{on/off (typ.)}}$	150 & 150 ns

Package

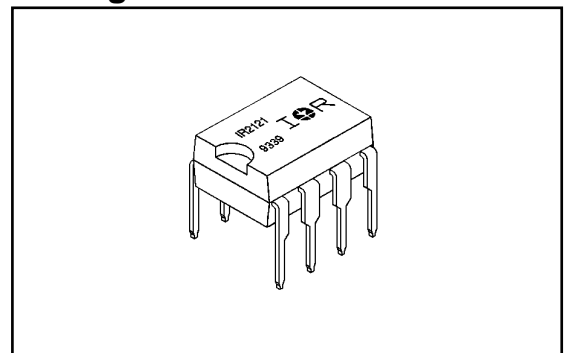

Typical Connection

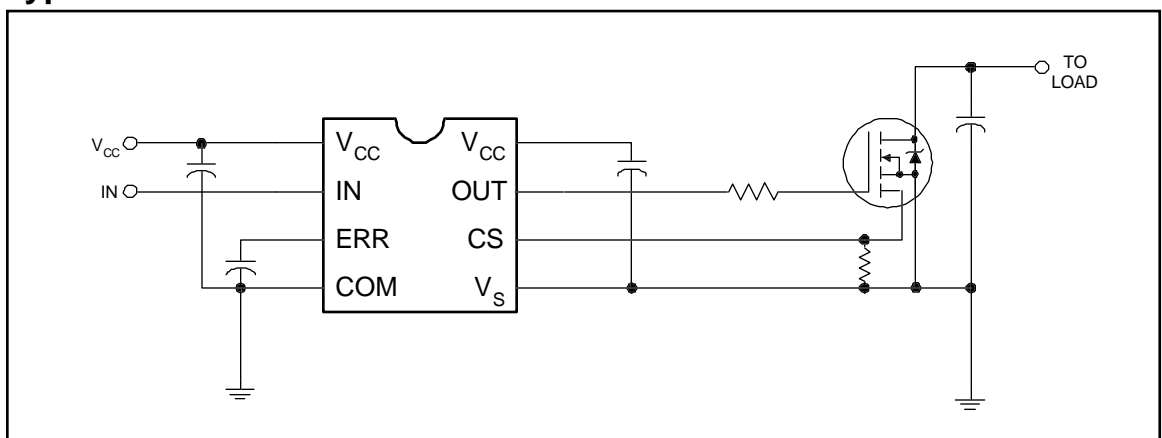

Absolute Maximum Ratings

Absolute Maximum Ratings indicate sustained limits beyond which damage to the device may occur. All voltage parameters are absolute voltages referenced to COM. The Thermal Resistance and Power Dissipation ratings are measured under board mounted and still air conditions.

Symbol	Parameter Definition	Value		Units
		Min.	Max.	
V _{CC}	Fixed Supply Voltage	-0.3	25	V
V _S	Gate Drive Return Voltage	V _{CC} - 25	V _{CC} + 0.3	
V _O	Output Voltage	V _S - 0.3	V _{CC} + 0.3	
V _{IN}	Logic Input Voltage	-0.3	V _{CC} + 0.3	
V _{ERR}	Error Signal Voltage	-0.3	V _{CC} + 0.3	
V _{CS}	Current Sense Voltage	V _S - 0.3	V _{CC} + 0.3	
P _D	Package Power Dissipation @ T _A ≤ +25°C	—	1.0	W
R _{θJA}	Thermal Resistance, Junction to Ambient	—	125	°C/W
T _J	Junction Temperature	—	150	°C
T _S	Storage Temperature	-55	150	
T _L	Lead Temperature (Soldering, 10 seconds)	—	300	

Recommended Operating Conditions

The Input/Output logic timing diagram is shown in Figure 1. For proper operation the device should be used within the recommended conditions. The V_S offset rating is tested with all supplies biased at 15V differential.

Symbol	Parameter Definition	Value		Units
		Min.	Max.	
V _{CC}	Fixed Supply Voltage	V _S + 10	V _S + 20	V
V _S	Gate Drive Return Voltage	-5	5	
V _O	Output Voltage	V _S	V _{CC}	
V _{IN}	Logic Input Voltage	0	V _{CC}	
V _{ERR}	Error Signal Voltage	0	V _{CC}	
V _{CS}	Current Sense Signal Voltage	V _S	V _{CC}	
T _A	Ambient Temperature	-40	125	°C

Dynamic Electrical Characteristics

V_{BIAS} (V_{CC}) = 15V, C_L = 3300 pF and T_A = 25°C unless otherwise specified. The dynamic electrical characteristics are defined in Figures 2 through 5.

Symbol	Parameter Definition	Figure	Value			Units	Test Conditions
			Min.	Typ.	Max.		
t_{on}	Turn-On Propagation Delay	7	—	150	200	ns	
t_{off}	Turn-Off Propagation Delay	8	—	150	190		
t_{sd}	ERR Shutdown Propagation Delay	9	—	1.7	2.2	μ s	
t_r	Turn-On Rise Time	10	—	43	60	ns	
t_f	Turn-Off Fall Time	11	—	26	35		
t_{cs}	CS Shutdown Propagation Delay	12	—	0.7	1.2	μ s	$C_{ERR} = 270$ pF
t_{err}	CS to ERR Pull-Up Propagation Delay	13	—	9.0	12		

Static Electrical Characteristics

V_{BIAS} (V_{CC}) = 15V and T_A = 25°C unless otherwise specified. The V_{IN} , V_{TH} and I_{IN} parameters are referenced to COM. The V_O and I_O parameters are referenced to V_S .

Symbol	Parameter Definition	Figure	Value			Units	Test Conditions
			Min.	Typ.	Max.		
V_{IH}	Logic "1" Input Voltage	14	2.2	—	—	V	$V_{CC} = 12V$ to $18V$
V_{IL}	Logic "0" Input Voltage	15	—	—	0.8		$V_{CC} = 12V$ to $18V$
V_{CSTH+}	CS Input Positive Going Threshold	16	150	230	320	mV	$V_{CC} = 12V$ to $18V$
V_{CSTH-}	CS Input Negative Going Threshold	17	130	200	260		$V_{CC} = 12V$ to $18V$
V_{OH}	High Level Output Voltage, $V_{BIAS} - V_O$	18	—	—	100		$I_O = 0A$
V_{OL}	Low Level Output Voltage, V_O	19	—	—	100		$I_O = 0A$
I_{QCC}	Quiescent VCC Supply Current	20	—	1.1	2.2	mA	$V_{IN} = V_{CS} = 0V$ or $5V$
I_{IN+}	Logic "1" Input Bias Current	21	—	4.5	10		$V_{IN} = 5V$
I_{IN-}	Logic "0" Input Bias Current	22	—	—	1.0	μ A	$V_{IN} = 0V$
I_{CS+}	"High" CS Bias Current	23	—	4.5	10		$V_{CS} = 3V$ or $5V$
I_{CS-}	"Low" CS Bias Current	24	—	—	1.0		$V_{CS} = 0V$
V_{CCUV+}	V_{CC} Supply Undervoltage Positive Going Threshold	25	8.3	8.9	9.6	V	
V_{CCUV-}	V_{CC} Supply Undervoltage Negative Going Threshold	26	7.3	8.0	8.7		
I_{ERR}	ERR Timing Charge Current	27	65	100	130	μ A	$V_{IN} = 5V, V_{CS} = 3V$ $ERR < V_{ERR+}$
I_{ERR+}	ERR Pull-Up Current	28	8.0	15	—		mA
I_{ERR-}	ERR Pull-Down Current	29	16	30	—	$V_{IN} = 0V$	
I_{O+}	Output High Short Circuit Pulsed Current	30	1.0	1.6	—	A	$V_O = 0V, V_{IN} = 5V$ $PW \leq 10$ μ s
I_{O-}	Output Low Short Circuit Pulsed Current	31	2.0	3.3	—		$V_O = 15V, V_{IN} = 0V$ $PW \leq 10$ μ s

Functional Block Diagram

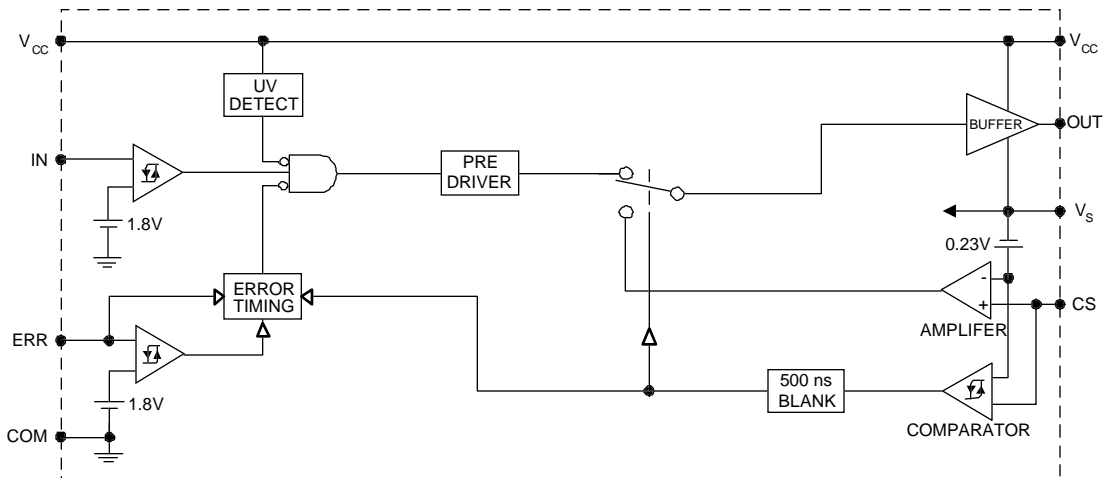

Lead Definitions

Symbol	Description
V_{CC}	Logic and gate drive supply
IN	Logic input for gate driver output (OUT), in phase with OUT
ERR	Serves multiple functions; status reporting, linear mode timing and cycle by cycle logic shutdown
COM	Logic ground
OUT	Gate drive output
V_S	Gate drive supply return
CS	Current sense input to current sense comparator

Lead Assignments

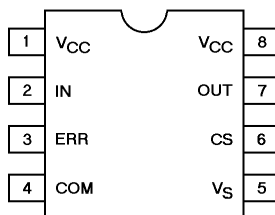

8 Lead DIP

IR2121

Part Number

Device Information

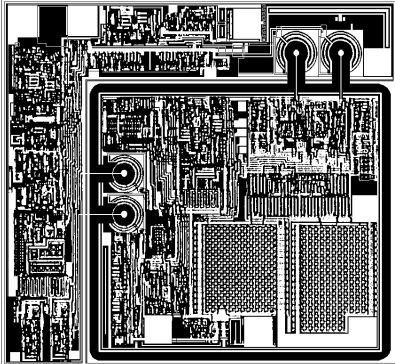
Process & Design Rule		HVDCMOS 4.0 μ m
Transistor Count		410
Die Size		104 X 111 X 26 (mil)
Die Outline		
Thickness of Gate Oxide		800Å
Connections	Material	Poly Silicon
	Width	4 μ m
First Layer	Spacing	6 μ m
	Thickness	5000Å
	Material	Al - Si (Si: 1.0% \pm 0.1%)
Second Layer	Width	6 μ m
	Spacing	9 μ m
	Thickness	20,000Å
Contact Hole Dimension		8 μ m X 8 μ m
Insulation Layer	Material	PSG (SiO ₂)
	Thickness	1.5 μ m
Passivation (1)	Material	PSG (SiO ₂)
	Thickness	1.5 μ m
Passivation (2)	Material	Proprietary*
	Thickness	Proprietary*
Method of Saw		Full Cut
Method of Die Bond		Ablebond 84 - 1
Wire Bond	Method	Thermo Sonic
	Material	Au (1.0 mil / 1.3 mil)
Leadframe	Material	Cu
	Die Area	Ag
	Lead Plating	Pb : Sn (37 : 63)
Package	Types	8 Lead PDIP
	Materials	EME6300 / MP150 / MP190
Remarks: * Patent Pending		

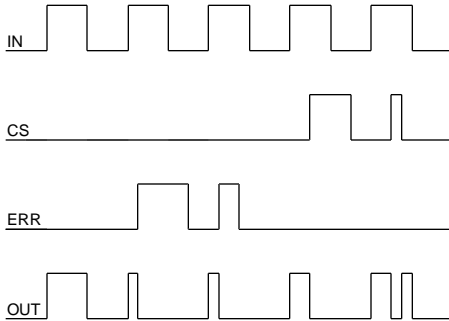

Figure 1. Input/Output Timing Diagram

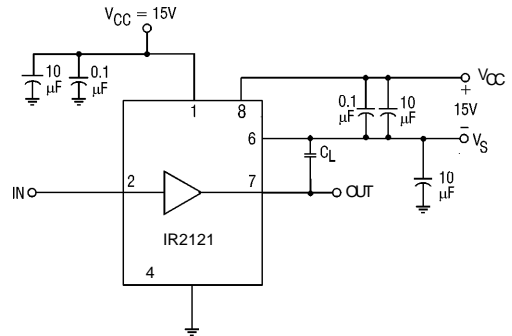

Figure 2. Switching Time Test Circuit

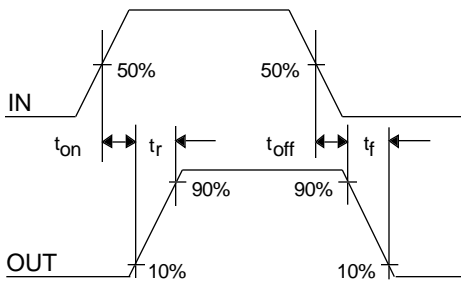

Figure 3. Switching Time Waveform Definitions

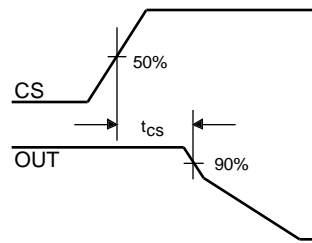

Figure 4. ERR Shutdown Waveform Definitions

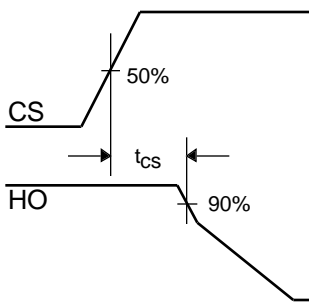
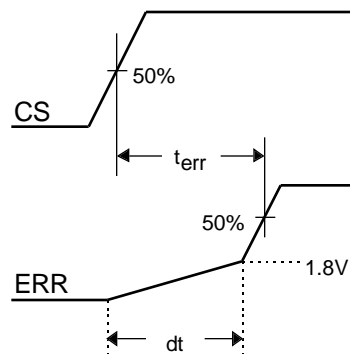

Figure 5. CS Shutdown Waveform Definitions



$$dt = C \times \frac{dV}{I_{ERR}} = C \times \frac{1.8V}{100 \mu A}$$

Figure 6. CS to ERR Waveform Definitions

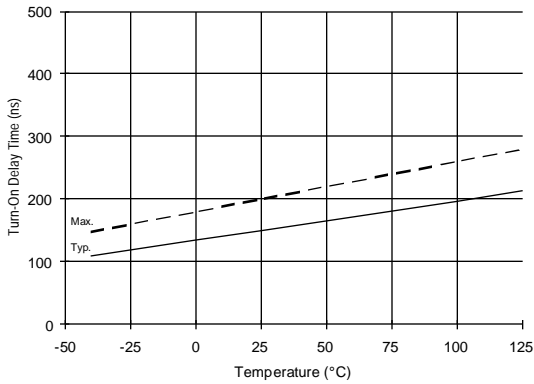

Figure 7A. Turn-On Time vs. Temperature

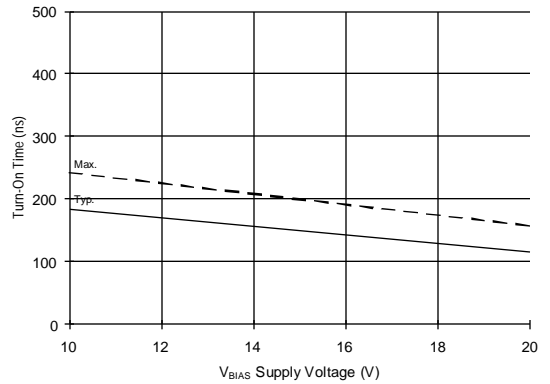

Figure 7B. Turn-On Time vs. Voltage

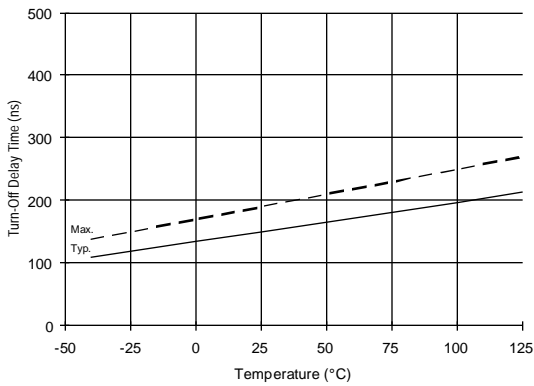

Figure 8A. Turn-Off Time vs. Temperature

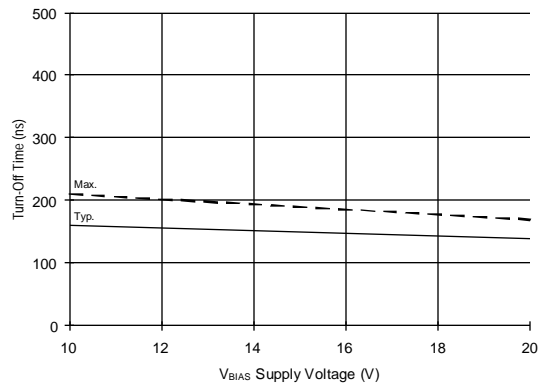

Figure 8B. Turn-Off Time vs. Voltage

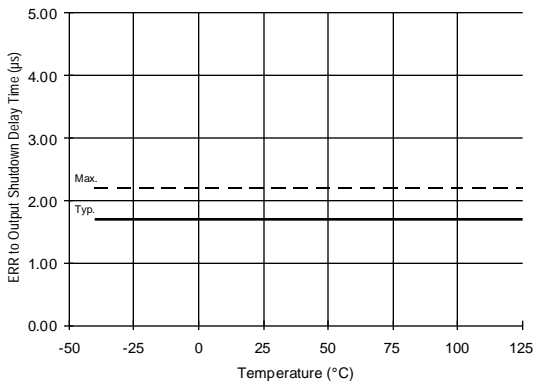

Figure 9A. ERR to Output Shutdown vs. Temperature

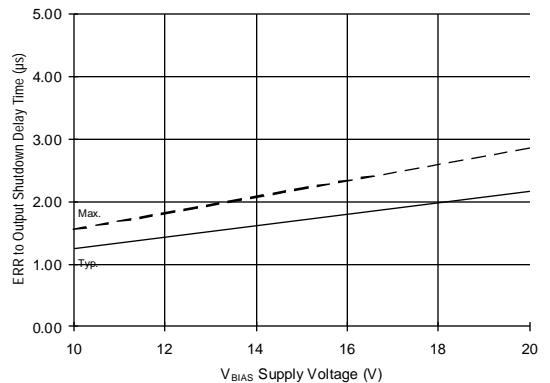

Figure 9B. ERR to Output Shutdown vs. Voltage

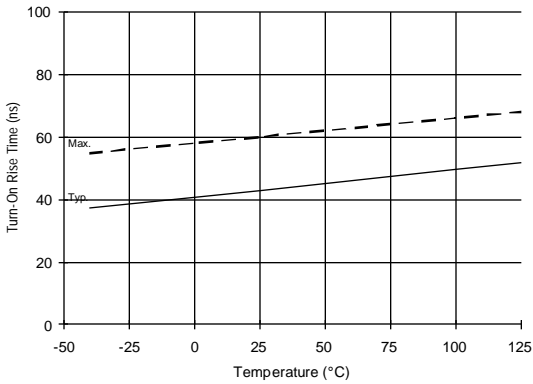

Figure 10A. Turn-On Rise Time vs. Temperature

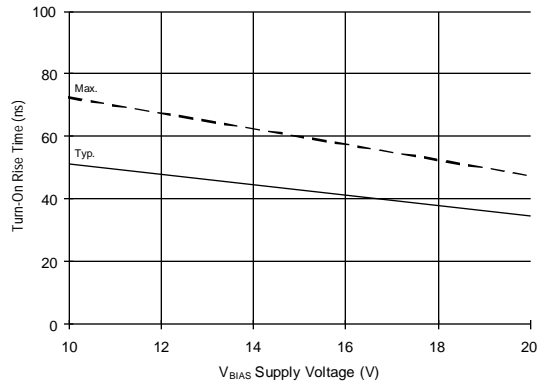

Figure 10B. Turn-On Rise Time vs. Voltage

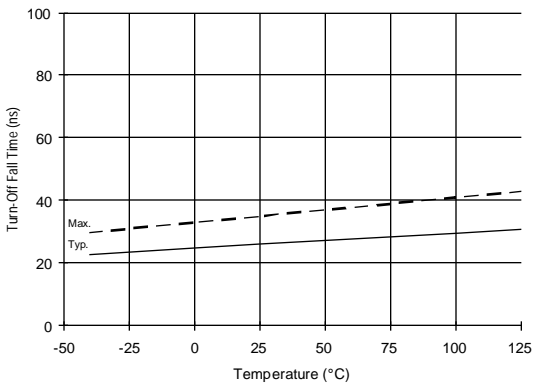

Figure 11A. Turn-Off Fall Time vs. Temperature

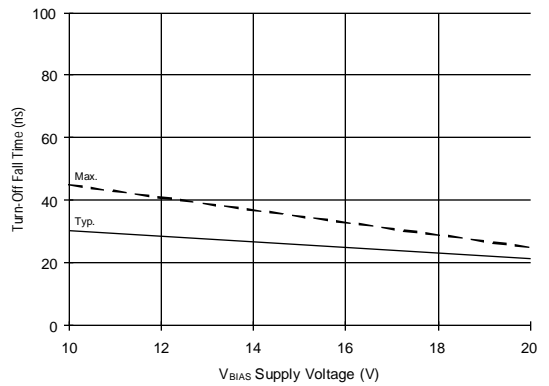

Figure 11B. Turn-Off Fall Time vs. Voltage

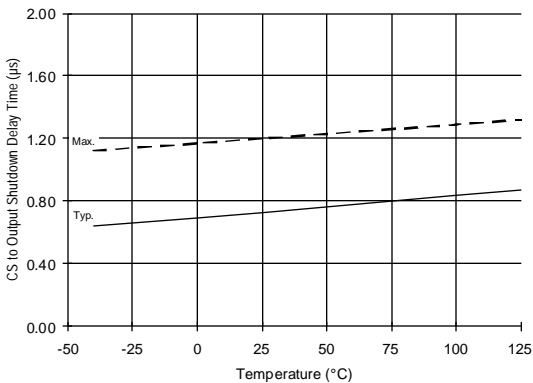

Figure 12A. CS to Output Shutdown vs. Temperature

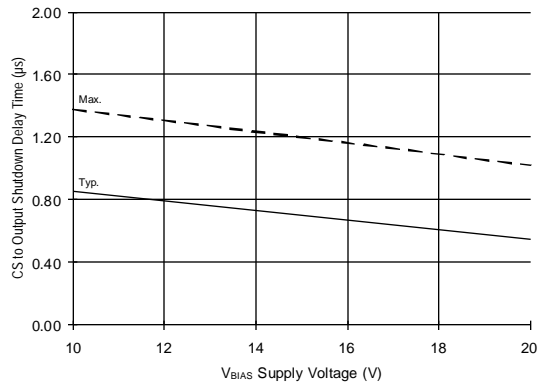

Figure 12B. CS to Output Shutdown vs. Voltage

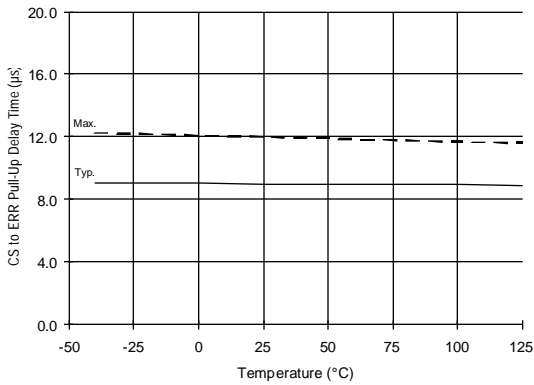

Figure 13A. CS to ERR Pull-Up vs. Temperature

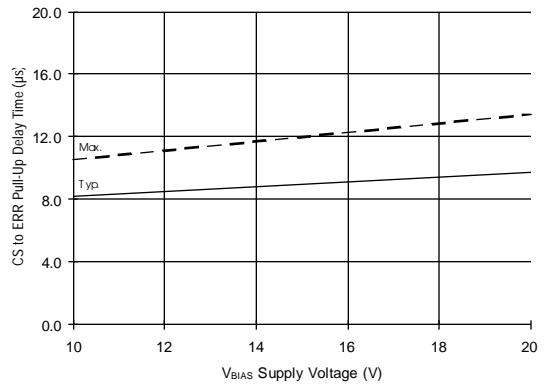

Figure 13B. CS to ERR Pull-Up vs. Voltage

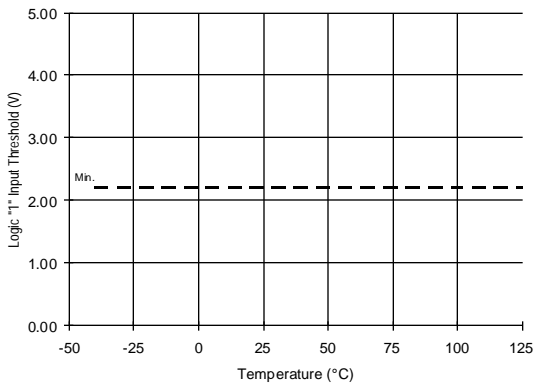

Figure 14A. Logic "1" Input Threshold vs. Temperature

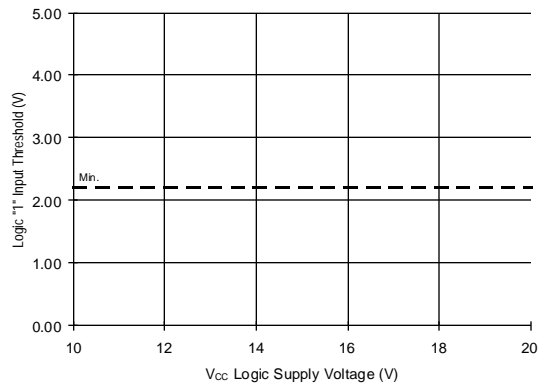

Figure 14B. Logic "1" Input Threshold vs. Voltage

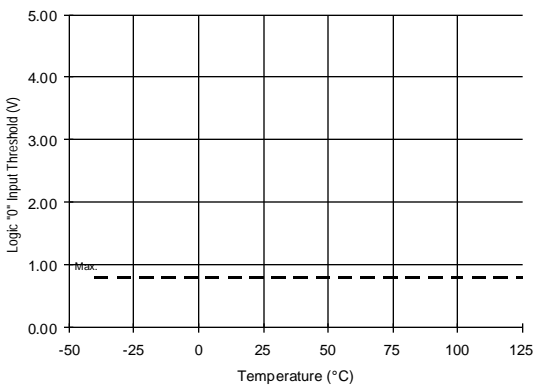

Figure 15A. Logic "0" Input Threshold vs. Temperature

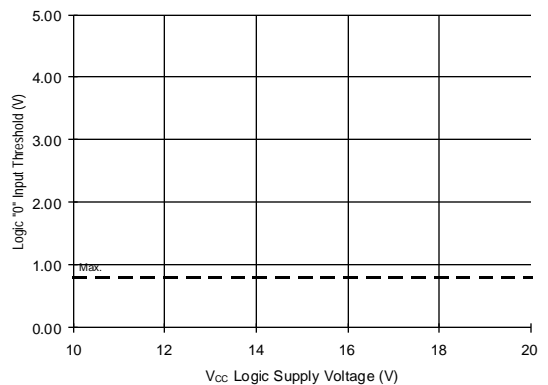

Figure 15B. Logic "0" Input Threshold vs. Voltage

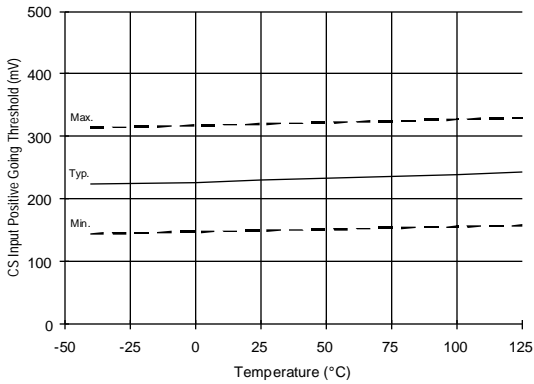

Figure 16A. CS Input Threshold (+) vs. Temperature

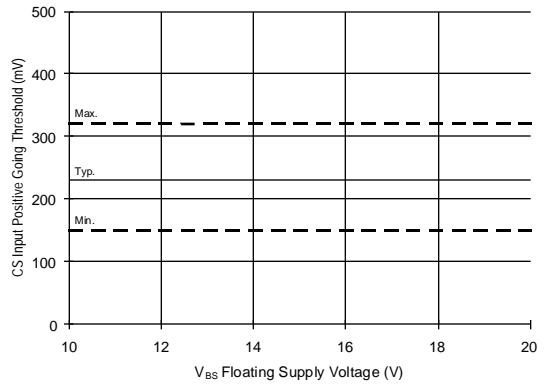

Figure 16B. CS Input Threshold (+) vs. Voltage

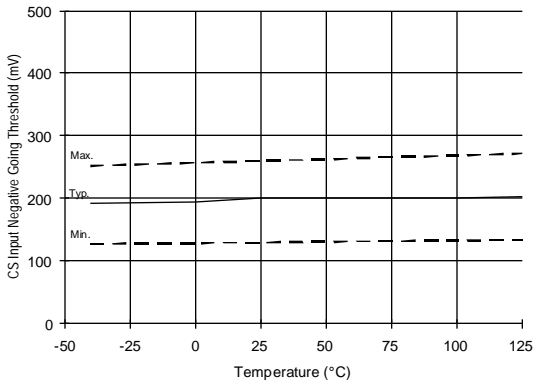

Figure 17A. CS Input Threshold (-) vs. Temperature

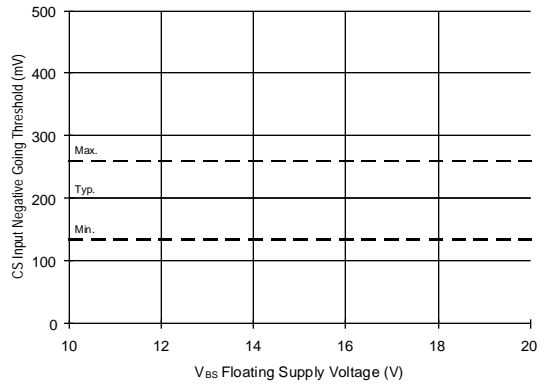

Figure 17B. CS Input Threshold (-) vs. Voltage

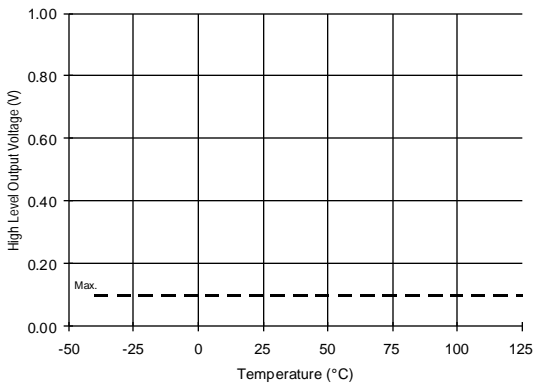

Figure 18A. High Level Output vs. Temperature

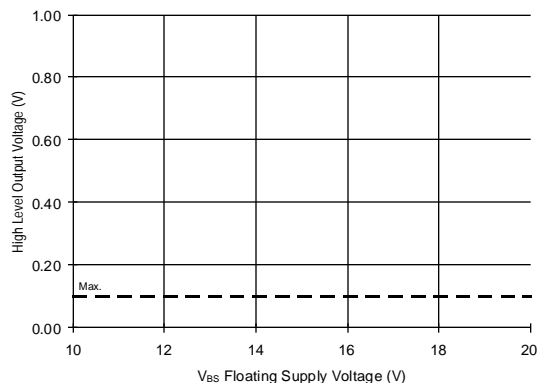

Figure 18B. High Level Output vs. Voltage

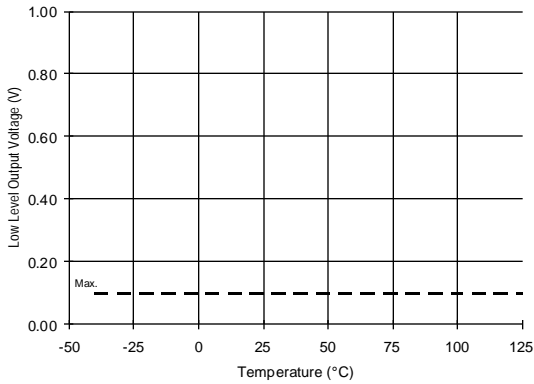

Figure 19A. Low Level Output vs. Temperature

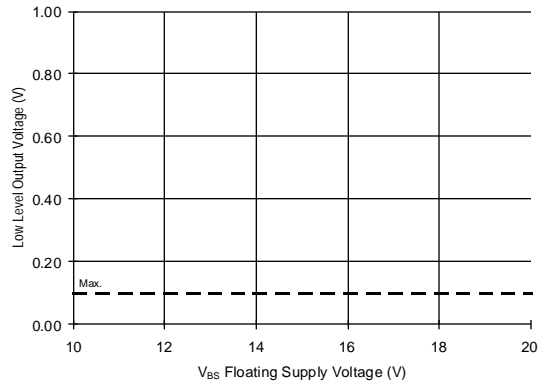

Figure 19B. Low Level Output vs. Voltage

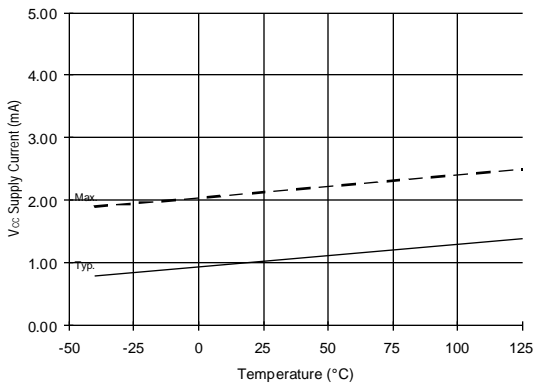

Figure 20A. V_{CC} Supply Current vs. Temperature

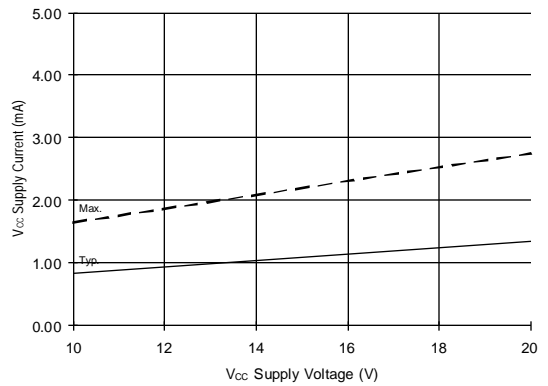

Figure 20B. V_{CC} Supply Current vs. Voltage

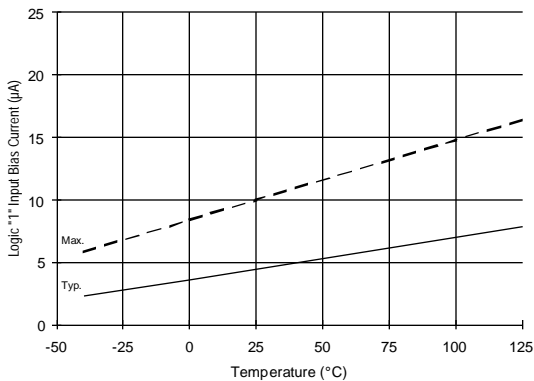

Figure 21A. Logic "1" Input Current vs. Temperature

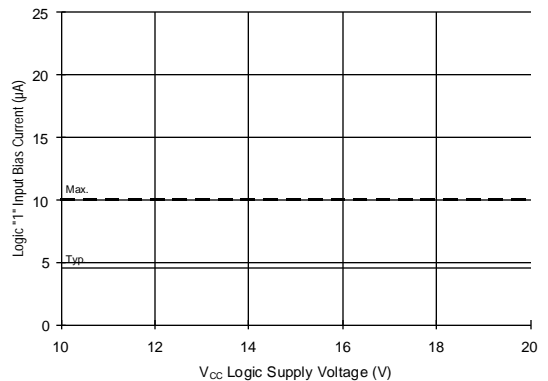

Figure 21B. Logic "1" Input Current vs. Voltage

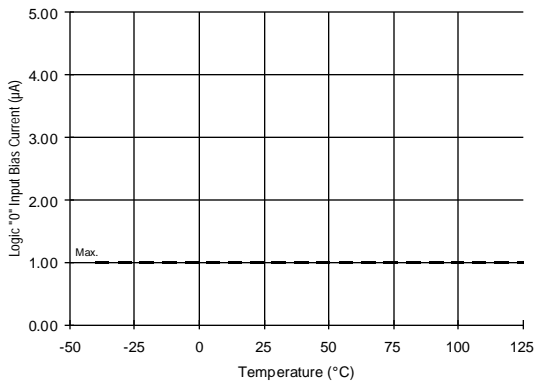

Figure 22A. Logic "0" Input Current vs. Temperature

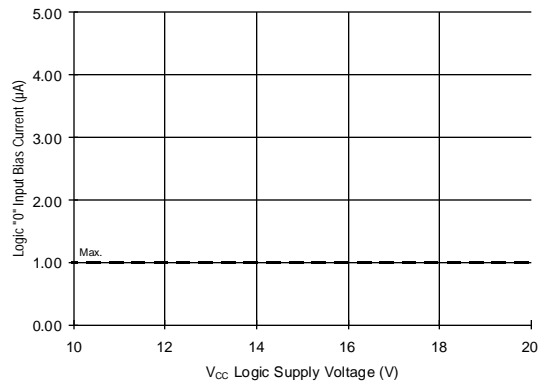

Figure 22B. Logic "0" Input Current vs. Voltage

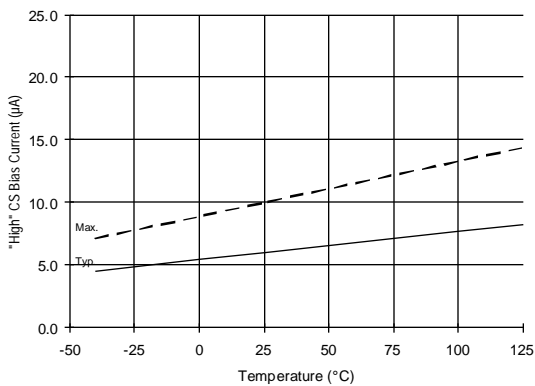

Figure 23A. "High" CS Bias Current vs. Temperature

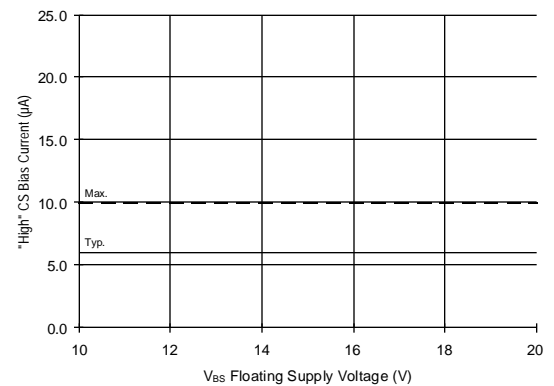

Figure 23B. "High" CS Bias Current vs. Voltage

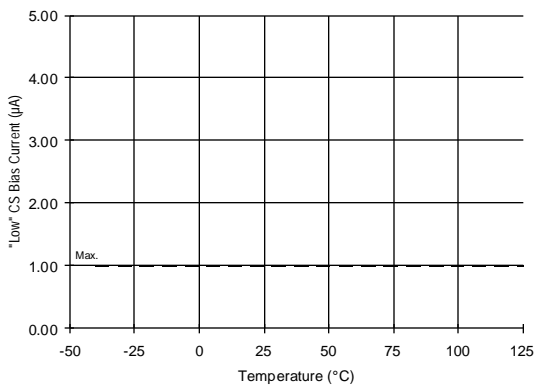

Figure 24A. "Low" CS Bias Current vs. Temperature

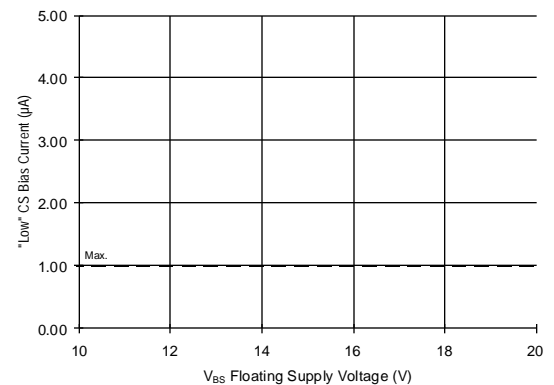

Figure 24B. "Low" CS Bias Current vs. Voltage

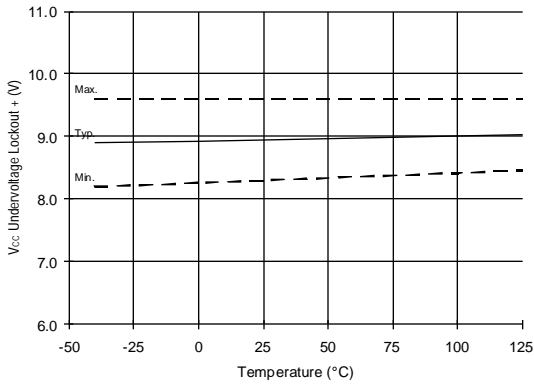

Figure 25. V_{CC} Undervoltage (+) vs. Temperature

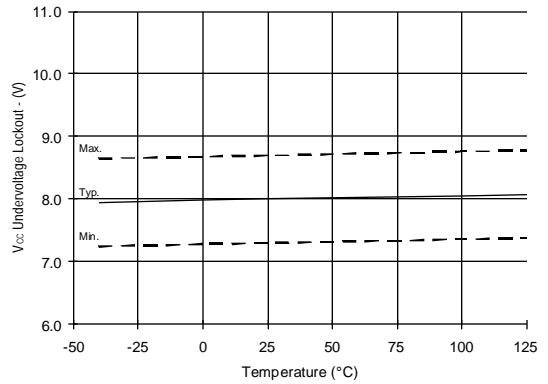

Figure 26. V_{CC} Undervoltage (-) vs. Temperature

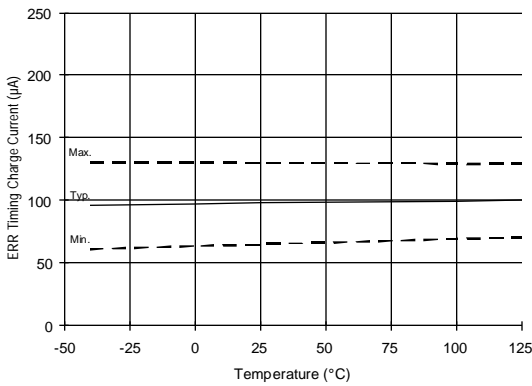

Figure 27A. ERR Timing Charge Current vs. Temperature

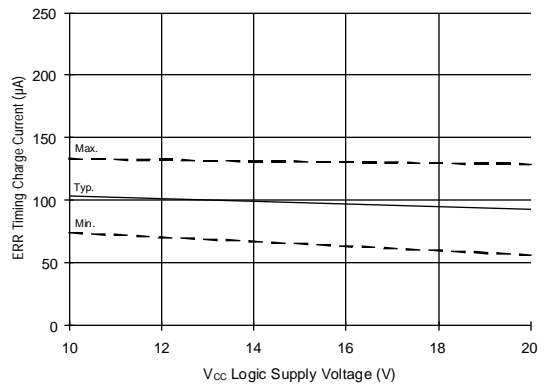

Figure 27B. ERR Timing Charge Current vs. Voltage

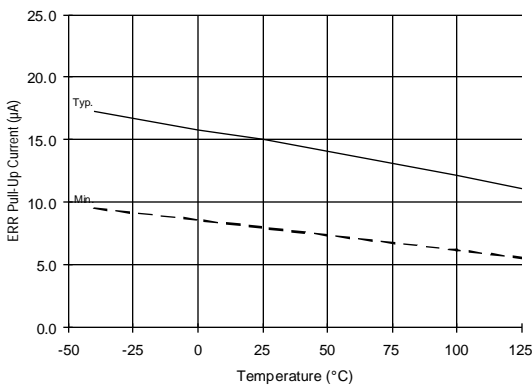

Figure 28A. ERR Pull-Up Current vs. Temperature

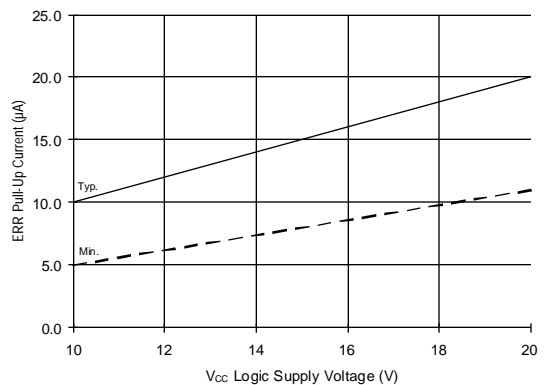

Figure 28B. ERR Pull-Up Current vs. Voltage

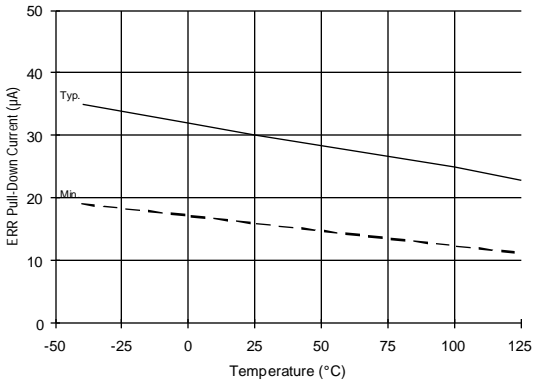

Figure 29A. ERR Pull-Down Current vs. Temperature

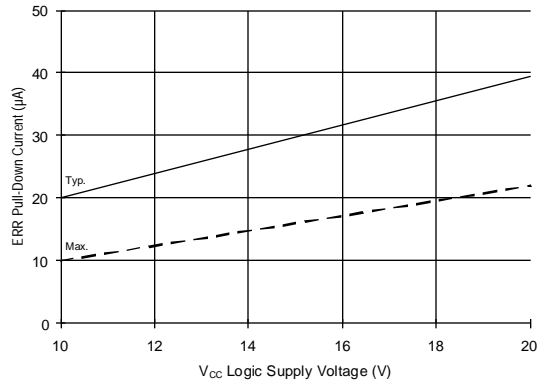

Figure 29B. ERR Pull-Down Current vs. Voltage

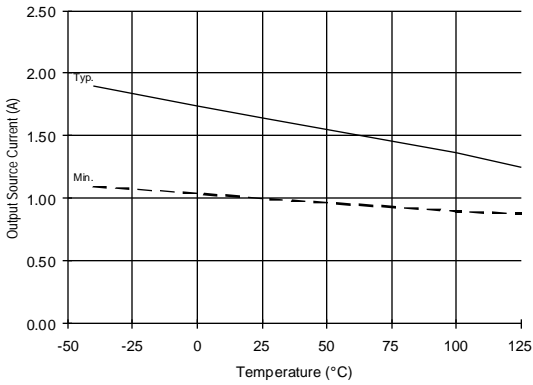

Figure 30A. Output Source Current vs. Temperature

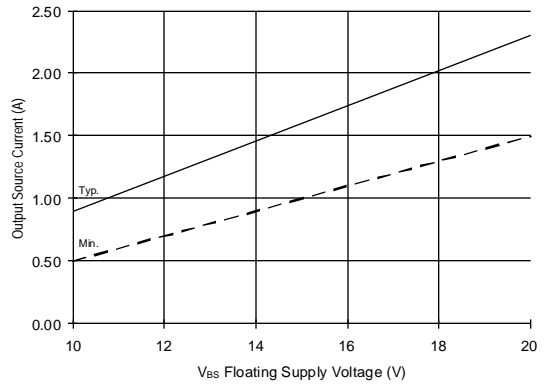

Figure 30B. Output Source Current vs. Voltage

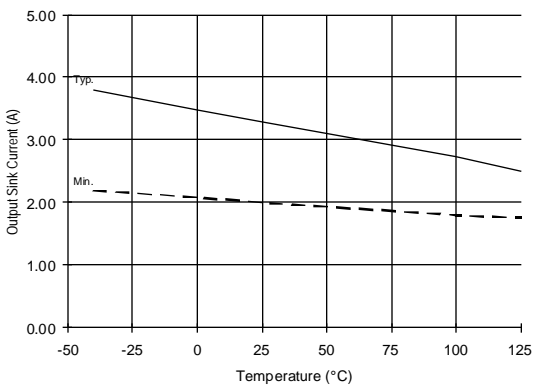

Figure 31A. Output Sink Current vs. Temperature

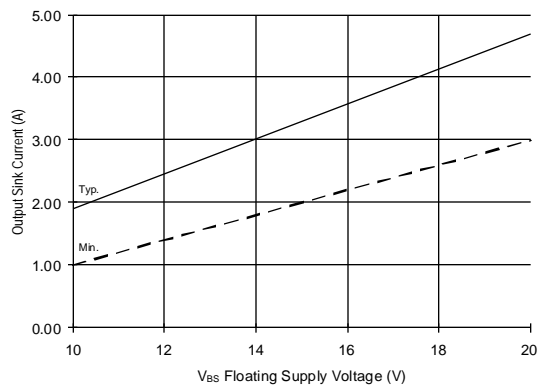

Figure 31B. Output Sink Current vs. Voltage

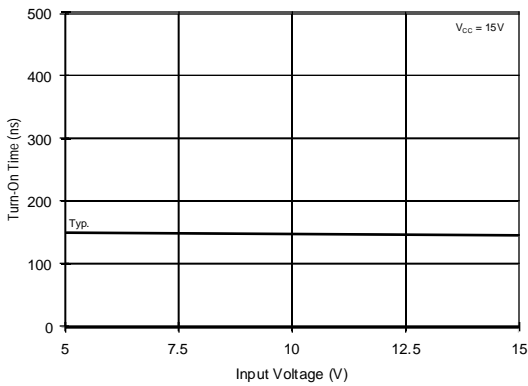

Figure 32A. Turn-On Time vs. Input Temperature

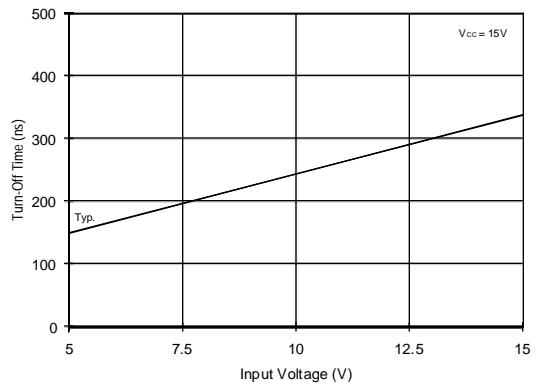

Figure 32B. Turn-Off Time vs. Input Voltage

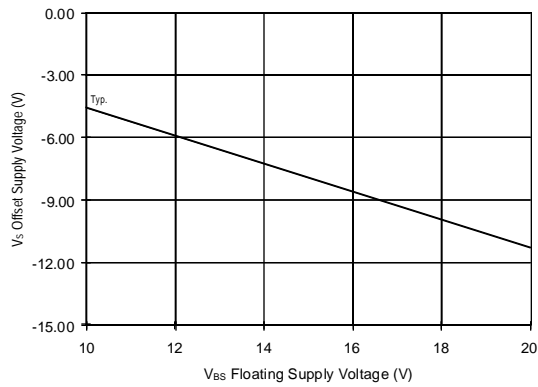

Figure 33. Maximum V_S Negative Offset vs. Supply Voltage