

**1.6W AUDIO AMPLIFIER**

- OPERATING VOLTAGE 1.8 TO 15 V
- LOW QUIESCENT CURRENT
- HIGH POWER CAPABILITY
- LOW CROSSOVER DISTORTION
- SOFT CLIPPING

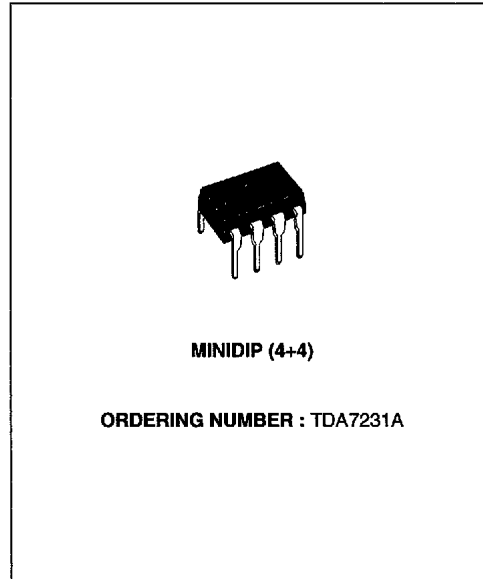

**DESCRIPTION**

The TDA7231A is a monolithic integrated circuit in 4 + 4 lead minidip package. It is intended for use as class AB power amplifier with wide range of supply voltage in portable radios, cassette recorders and players, etc.

**PIN CONNECTION**

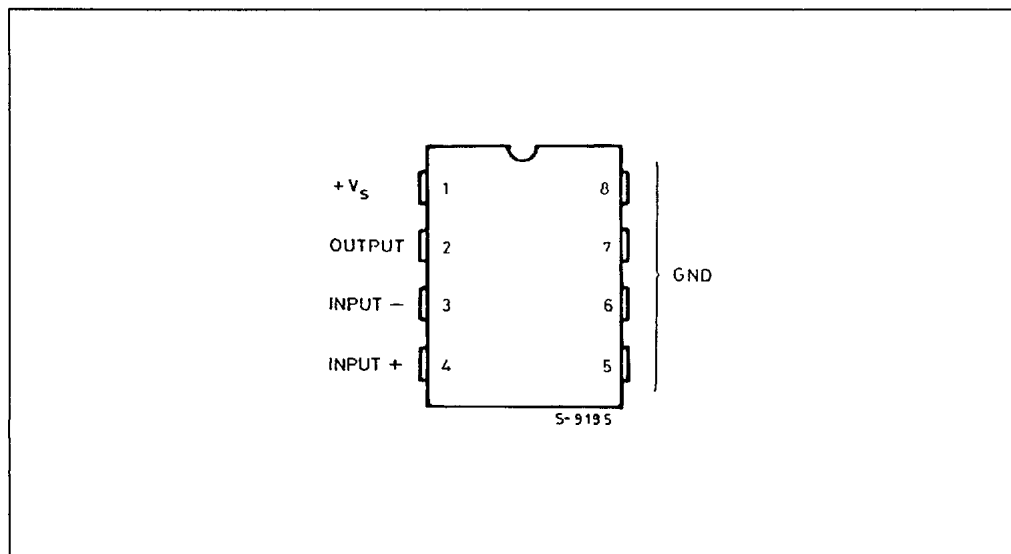

## TDA7231A

### ABSOLUTE MAXIMUM RATINGS

Symbol	Parameter	Value	Unit
$V_s$	Supply Voltage	16	V
$P_{tot}$	Total Power Dissipation at $T_{amb} = 50\text{ }^\circ\text{C}$ at $T_{case} = 70\text{ }^\circ\text{C}$	1.25 4	W W
$I_o$	Output Peak Current	1	A
$T_{stg}, T_j$	Storage and Junction Temperature	-40 to 150	$^\circ\text{C}$

### THERMAL DATA

Symbol	Parameter	Value	Unit
$R_{th\ j-amb}$	Thermal Resistance Junction-ambient Max.	80	$^\circ\text{C/W}$
$R_{th\ j-pins}$	Thermal Resistance Junction-pins Max.	15	$^\circ\text{C/W}$

### ELECTRICAL CHARACTERISTICS ( $V_s = 6\text{ V}$ , $T_{amb} = 25\text{ }^\circ\text{C}$ , unless otherwise specified)

Symbol	Parameter	Test Conditions	Min.	Typ.	Max.	Unit
$V_s$	Supply Voltage		1.8		15	V
$V_o$	Quiescent Out Voltage	$V_s = 6\text{ V}$ $V_s = 3\text{ V}$		2.7 1.2		V V
$I_d$	Quiescent Drain Current			3.6	9	mA
$I_b$	Input Bias Current			100		nA
$P_o$	Output Power	$d = 10\%$ $f = 1\text{ kHz}$ $V_s = 12\text{ V}$ $R_L = 8\ \Omega$ $V_s = 9\text{ V}$ $R_L = 4\ \Omega$ $V_s = 6\text{ V}$ $R_L = 8\ \Omega$ $V_s = 6\text{ V}$ $R_L = 4\ \Omega$ $V_s = 3\text{ V}$ $R_L = 4\ \Omega$ $V_s = 3\text{ V}$ $R_L = 8\ \Omega$		1.8 1.6 0.4 0.7 110 70		W W W W mW mW
$d$	Distortion	$P_o = 0.2\text{ W}$ $f = 1\text{ kHz}$ $R_L = 8\ \Omega$		0.3		%
$G_v$	Closed Loop Voltage Gain			38		dB
$R_{in}$	Input Resistance	$f = 1\text{ kHz}$	100			k $\Omega$
$e_N$	Total Input Noise	$R_s = 10\text{ k}\Omega$ B = Curve A B = 22Hz to 22kHz		2 3		$\mu\text{V}$ $\mu\text{V}$
SVR	Supply Voltage Rejection	$f = 100\text{ Hz}$ , $R_g = 10\text{ k}\Omega$	24	33		dB

Figure 1 : Test and Application Circuit

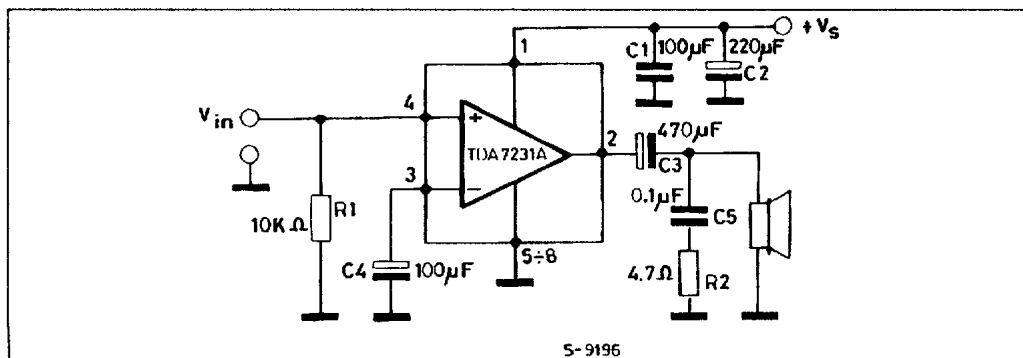

Figure 2 : P.C. Board and Components Layout of the figure 1 (1:1 scale)

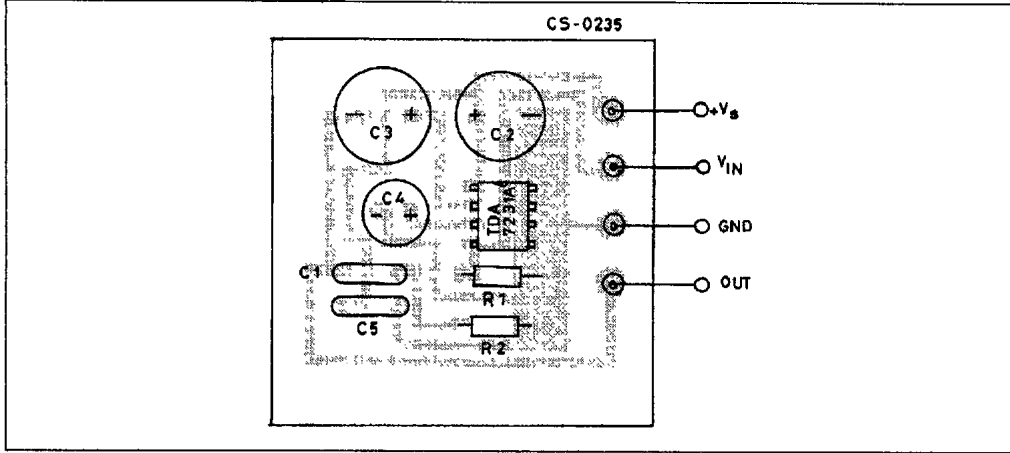

Figure 3 : Output Power versus Supply Voltage

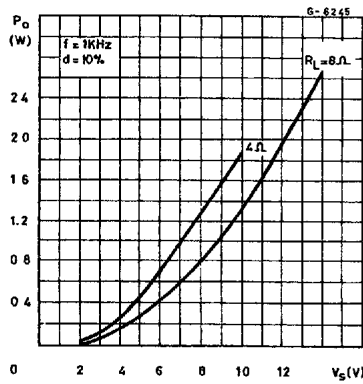

Figure 5 : Quiescent Output Voltage versus Supply Voltage

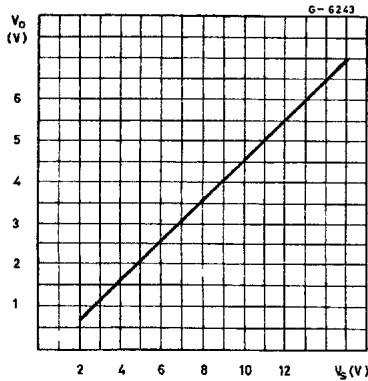

Figure 4 : Quiescent Current versus Supply Voltage

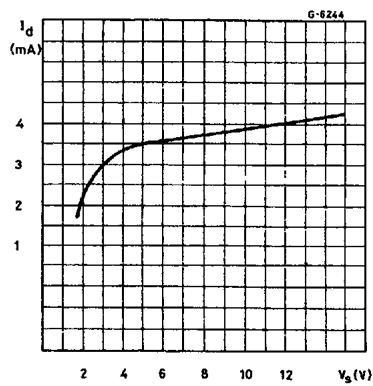

Figure 6 : Supply Voltage Rejection versus Frequency

