

TPA1517 6-W STEREO AUDIO POWER AMPLIFIER

SLOS162B – MARCH 1997 – REVISED MARCH 2000

- TDA1517P Compatible
- High Power Outputs (6 W/Channel)
- Surface Mount Availability
20-Pin Thermal SOIC PowerPAD™
- Thermal Protection
- Fixed Gain . . . 20 dB
- Mute and Standby Operation
- Supply Range . . . 9.5 V – 18 V

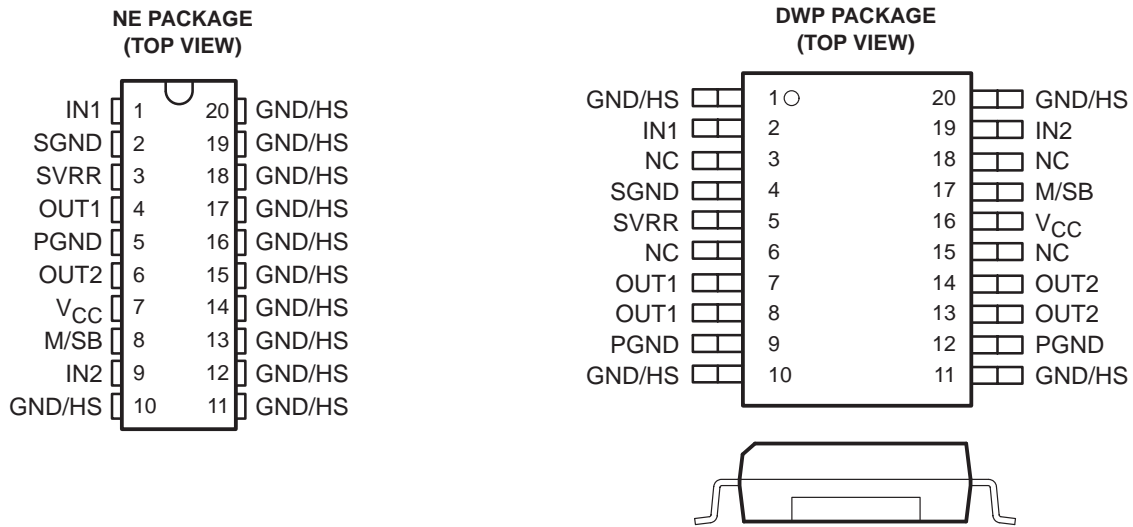

Cross Section View Showing PowerPAD

NC – No internal connection

description

The TPA1517 is a stereo audio power amplifier that contains two identical amplifiers capable of delivering 6 W per channel of continuous average power into a 4-Ω load at 10% THD+N or 5 W per channel at 1% THD+N. The gain of each channel is fixed at 20 dB. The amplifier features a mute/standby function for power-sensitive applications. The amplifier is available in Texas Instruments patented PowerPAD 20-pin surface-mount thermally-enhanced package (DWP) that reduces board space and facilitates automated assembly while maintaining exceptional thermal characteristics. It is also available in the 20-pin thermally enhanced DIP package (NE).

AVAILABLE OPTIONS

T _A	PACKAGED DEVICES	
	THERMALLY ENHANCED PLASTIC DIP	THERMALLY† ENHANCED SURFACE MOUNT (DWP)
-40°C to 85°C	TPA1517NE	TPA1517DWP

† The DWP package is available taped and reeled. To order a taped and reeled part, add the suffix R (e.g., TPA1517DWPR).



Please be aware that an important notice concerning availability, standard warranty, and use in critical applications of Texas Instruments semiconductor products and disclaimers thereto appears at the end of this data sheet.

PowerPAD is a trademark of Texas Instruments Incorporated.

PRODUCTION DATA information is current as of publication date. Products conform to specifications per the terms of Texas Instruments standard warranty. Production processing does not necessarily include testing of all parameters.



POST OFFICE BOX 655303 • DALLAS, TEXAS 75265

Copyright © 2000, Texas Instruments Incorporated

TPA1517

6-W STEREO AUDIO POWER AMPLIFIER

SLOS162B – MARCH 1997 – REVISED MARCH 2000

Terminal Functions

TERMINAL NAME	TERMINAL		I/O	DESCRIPTION
	DWP NO.	NE NO.		
IN1	2	1	I	IN1 is the audio input for channel 1.
SGND	4	2	I	SGND is the input signal ground reference.
SVRR	5	3		SVRR is the midrail bypass mode enable.
OUT1	7, 8	4	O	OUT1 is the audio output for channel 1.
PGND	9, 12	5		PGND is the power ground reference.
OUT2	13, 14	6	O	OUT2 is the audio output for channel 2.
V _{CC}	16	7	I	V _{CC} is the supply voltage input.
M/SB	17	8	I	M/SB is the mute/standby mode enable. When held at less than 2 V, this signal enables the TPA1517 for standby operation. When held between 3.4 V and 8.8 V, this signal enables the TPA1517 for mute operation. When held above 9.2 V, the TPA1517 operates normally.
IN2	19	9	I	IN2 is the audio input for channel 2.
GND/HS	1, 10, 11, 20	10– 20		GND/HS are the ground and heatsink connections. All GND/HS terminals are connected directly to the mount pad for thermal-enhanced operation.

absolute maximum ratings over operating free-air temperature range (unless otherwise noted)†

Supply voltage, V _{CC}	22 V
Input voltage, V _I (IN1, IN2)	22 V
Continuous total power dissipation	Internally limited (See Dissipation Rating Table)
Operating free-air temperature range, T _A	–40°C to 85°C
Operating junction temperature range, T _J	–40°C to 150°C
Storage temperature range, T _{stg}	–65°C to 150°C
Lead temperature 1,6 mm (1/16 inch) from case for 10 seconds: DWP or NE package	260°C

† Stresses beyond those listed under “absolute maximum ratings” may cause permanent damage to the device. These are stress ratings only, and functional operation of the device at these or any other conditions beyond those indicated under “recommended operating conditions” is not implied. Exposure to absolute-maximum-rated conditions for extended periods may affect device reliability.

NOTE 1: These devices have been classified as Class 1 ESD sensitive products per MIL-PRF-38535 Method 3015.7. Appropriate precautions should be taken to prevent serious damage to the device.

DISSIPATION RATING TABLE

PACKAGE	T _A ≤ 25°C	DERATING FACTOR	T _A = 70°C	T _A = 85°C
DWP‡	2.94 W	23.5 mW/°C	1.88 W	1.53 W
NE‡	2.85 W	22.8 mW/°C	1.82 W	1.48 W

‡ See the Texas Instruments document, *PowerPAD Thermally Enhanced Package Application Report* (literature number SLMA002), for more information on the PowerPAD package. The thermal data was measured on a PCB layout based on the information in the section entitled *Texas Instruments Recommended Board for PowerPAD* on page 33 of the before mentioned document.

recommended operating conditions

	MIN	NOM	MAX	UNIT
Supply voltage, V _{CC}	9.5		18	V
Operating free-air temperature, T _A	–40		85	°C



POST OFFICE BOX 655303 • DALLAS, TEXAS 75265

TPA1517

6-W STEREO AUDIO POWER AMPLIFIER

SLOS162B – MARCH 1997 – REVISED MARCH 2000

electrical characteristics, $V_{CC} = 12\text{ V}$, $T_A = 25^\circ\text{C}$ (unless otherwise noted)

PARAMETER		TEST CONDITIONS	MIN	TYP	MAX	UNIT
I_{CC}	Supply current			45	70	mA
$V_{O(DC)}$	DC output voltage	See Note 2		4		V
$V_{(M/SB)}$	M/SB on voltage			9.5		V
$V_{O(M)}$	Mute output voltage	$V_I = 1\text{ V (max)}$		2		mV
$I_{CC(SB)}$	Supply current in standby mode			7	100	μA

NOTE 2: At $6\text{ V} < V_{CC} < 18\text{ V}$ the DC output voltage is approximately $V_{CC}/2$.

electrical characteristics, $V_{CC} = 14.5\text{ V}$, $T_A = 25^\circ\text{C}$ (unless otherwise noted)

PARAMETER		TEST CONDITIONS	MIN	TYP	MAX	UNIT
I_{CC}	Supply current			50	80	mA
$V_{O(DC)}$	DC output voltage	See Note 2		5		V
$V_{(M/SB)}$	Voltage on M/SB terminal for normal operation			9.5		V
$V_{O(M)}$	Mute output voltage	$V_I = 1\text{ V (max)}$		2		mV
$I_{CC(SB)}$	Supply current in standby mode			7	100	μA

NOTE 2: At $6\text{ V} < V_{CC} < 18\text{ V}$ the DC output voltage is approximately $V_{CC}/2$.

operating characteristic, $V_{CC} = 12\text{ V}$, $R_L = 4\ \Omega$, $f = 1\text{ kHz}$, $T_A = 25^\circ\text{C}$

PARAMETER		TEST CONDITIONS	MIN	TYP	MAX	UNIT
P_O	Output power (see Note 3)	THD = 0.2%		3		W
		THD = 10%		6		
SNR	Signal-to-noise ratio			84		dB
THD	Total harmonic distortion	$P_O = 1\text{ W}$, $R_L = 8\ \Omega$, $f = 1\text{ kHz}$		0.1%		
$I_{O(SM)}$	Non-repetitive peak output current			4		A
$I_{O(RM)}$	Repetitive peak output current			2.5		A
	Low-frequency roll-off	-3 dB		45		Hz
	High-frequency roll-off	-1 dB	20			kHz
	Supply ripple rejection ratio	M/SB = On, $f = 1\text{ kHz}$		65		dB
Z_I	Input impedance			60		k Ω
V_n	Noise output voltage (see Note 4)	$R_S = 0$, M/SB = On		50		$\mu\text{V(rms)}$
		$R_S = 10\text{ k}\Omega$, M/SB = On		70		$\mu\text{V(rms)}$
		M/SB = Mute		50		$\mu\text{V(rms)}$
	Channel separation	$R_S = 10\text{ k}\Omega$		58		dB
	Gain		18.5	20	21	
	Channel balance			0.1	1	dB

- NOTES: 3. Output power is measured at the output terminals of the IC.
 4. Noise voltage is measured in a bandwidth of 20 Hz to 20 kHz.



TPA1517

6-W STEREO AUDIO POWER AMPLIFIER

SLOS162B – MARCH 1997 – REVISED MARCH 2000

operating characteristic, $V_{CC} = 14.5\text{ V}$, $R_L = 4\ \Omega$, $f = 1\text{ kHz}$, $T_A = 25^\circ\text{C}$

PARAMETER		TEST CONDITIONS	MIN	TYP	MAX	UNIT
P _O	Output power (see Note 3)	THD = 0.2%		4.5		W
		THD < 10%		6		W
SNR	Signal-to-noise ratio			84		dB
THD	Total harmonic distortion	P _O = 1 W		0.1%		
I _{O(SM)}	Non-repetitive peak output current			4		A
I _{O(RM)}	Repetitive peak output current			2.5		A
	Low-frequency roll-off	-3 dB		45		Hz
	High-frequency roll-off	-1 dB	20			kHz
	Supply ripple rejection ratio	M/SB = On		65		dB
Z _I	Input impedance			60		k Ω
V _n	Noise output voltage (see Note 4)	R _S = 0, M/SB = On		50		$\mu\text{V(rms)}$
		R _S = 10 k Ω , M/SB = On		70		$\mu\text{V(rms)}$
		M/SB = Mute		50		$\mu\text{V(rms)}$
	Channel separation	R _S = 10 k Ω		58		dB
	Gain		18.5	20	21	dB
	Channel balance			0.1	1	dB

- NOTES: 3. Output power is measured at the output terminals of the IC.
 4. Noise voltage is measured in a bandwidth of 22 Hz to 22 kHz.

TYPICAL CHARACTERISTICS

Table of Graphs

			FIGURE
I _{CC}	Supply current	vs Supply voltage	1
	Power supply rejection ratio	vs Frequency	2, 3
THD + N	Total harmonic distortion plus noise	V _{CC} = 12 V vs Frequency vs Power output	4, 5, 6 10, 11
		V _{CC} = 14.5 V vs Frequency vs Power output	7, 8, 9 12, 13
	Crosstalk	vs Frequency	14, 15
	Gain	vs Frequency	16
	Phase	vs Frequency	16
V _n	Noise voltage	vs Frequency	17, 18
P _O	Output power	vs Supply voltage	19
		vs Load resistance	20
P _D	Power dissipation	vs Output power	21, 22



TYPICAL CHARACTERISTICS

SUPPLY CURRENT
vs
SUPPLY VOLTAGE

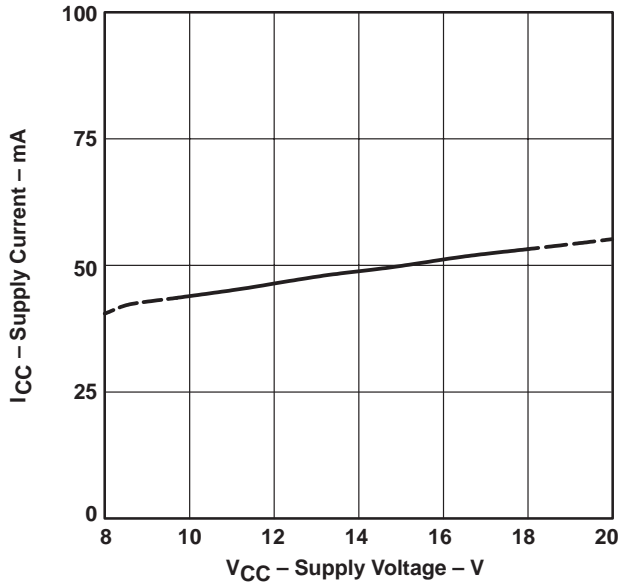

Figure 1

SUPPLY RIPPLE REJECTION RATIO
vs
FREQUENCY

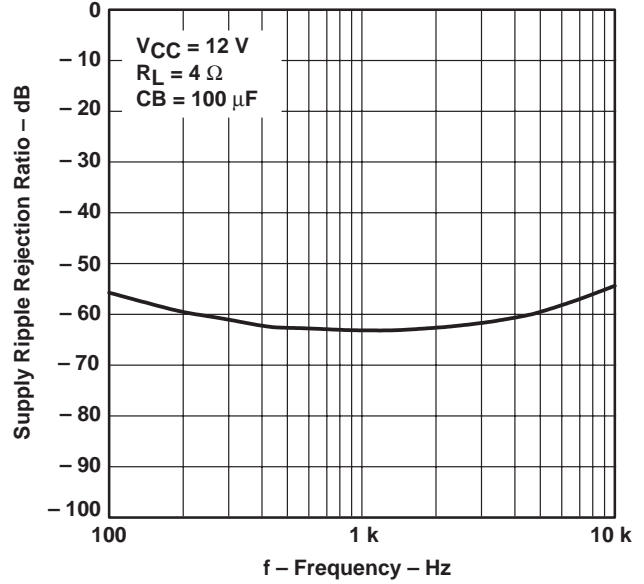

Figure 2

SUPPLY RIPPLE REJECTION RATIO
vs
FREQUENCY

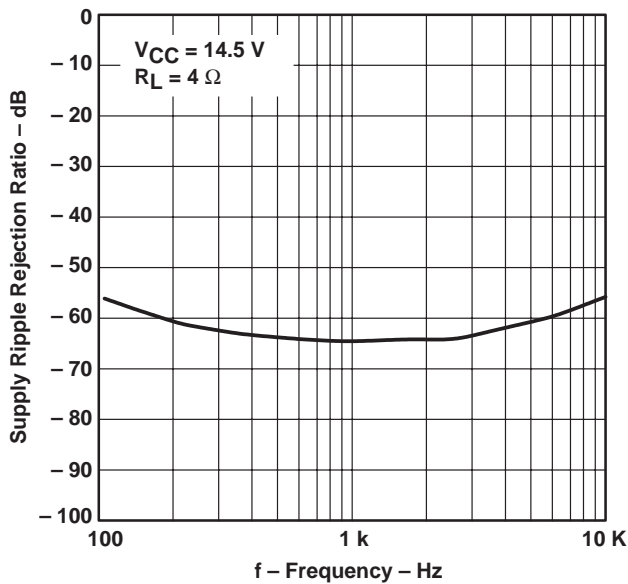

Figure 3

TOTAL HARMONIC DISTORTION PLUS NOISE
vs
FREQUENCY

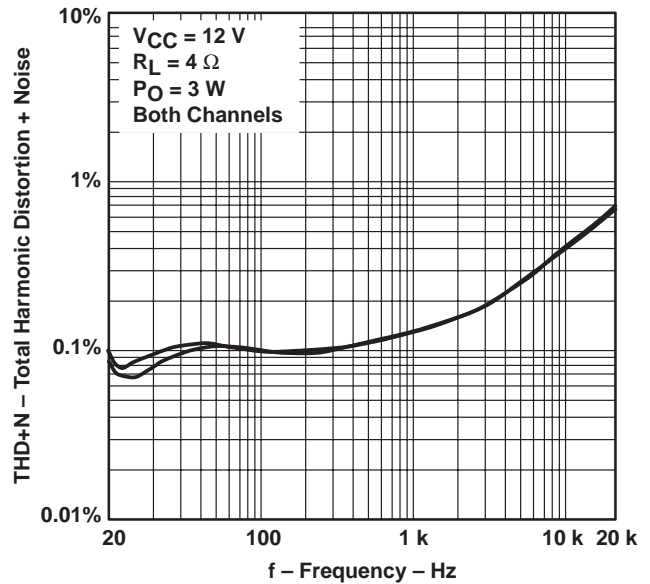

Figure 4

TPA1517 6-W STEREO AUDIO POWER AMPLIFIER

SLOS162B – MARCH 1997 – REVISED MARCH 2000

TYPICAL CHARACTERISTICS

TOTAL HARMONIC DISTORTION PLUS NOISE
vs
FREQUENCY

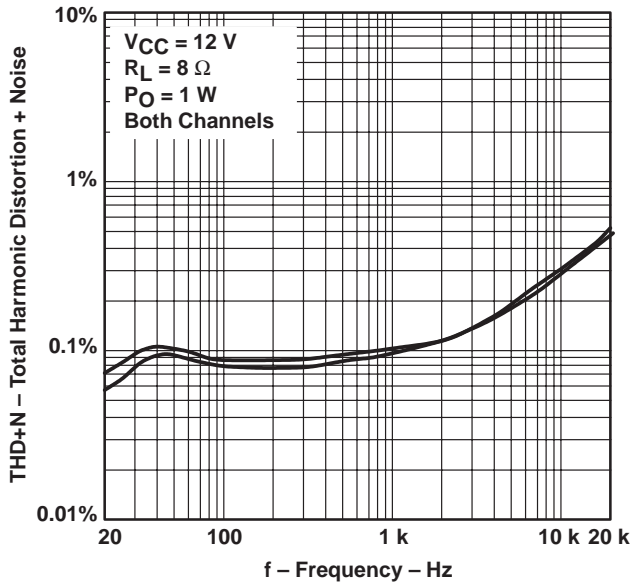

Figure 5

TOTAL HARMONIC DISTORTION PLUS NOISE
vs
FREQUENCY

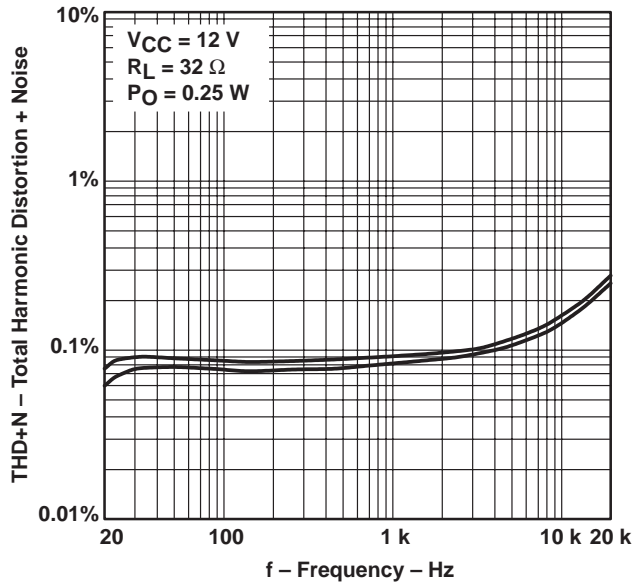

Figure 6

TOTAL HARMONIC DISTORTION PLUS NOISE
vs
FREQUENCY

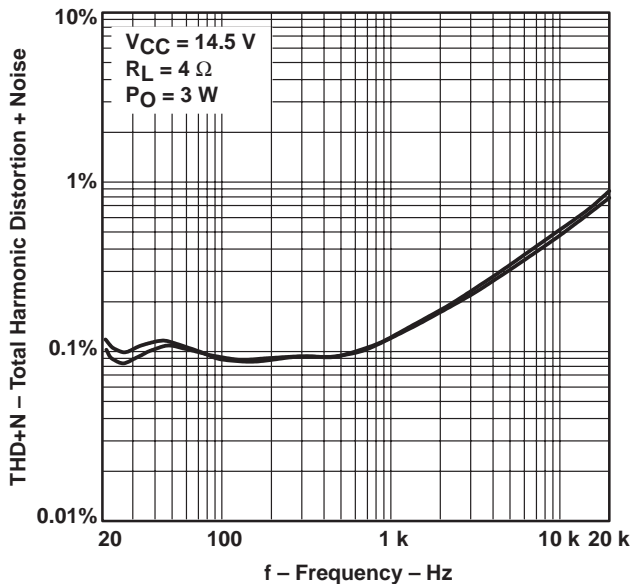

Figure 7

TOTAL HARMONIC DISTORTION PLUS NOISE
vs
FREQUENCY

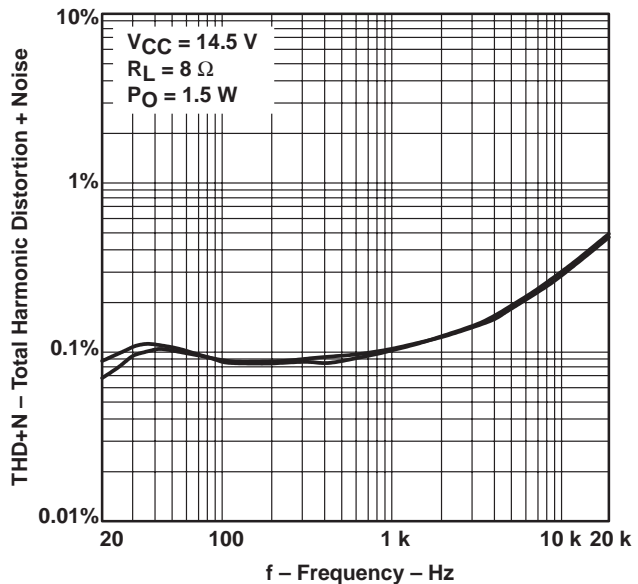

Figure 8



TYPICAL CHARACTERISTICS

TOTAL HARMONIC DISTORTION PLUS NOISE
vs
FREQUENCY

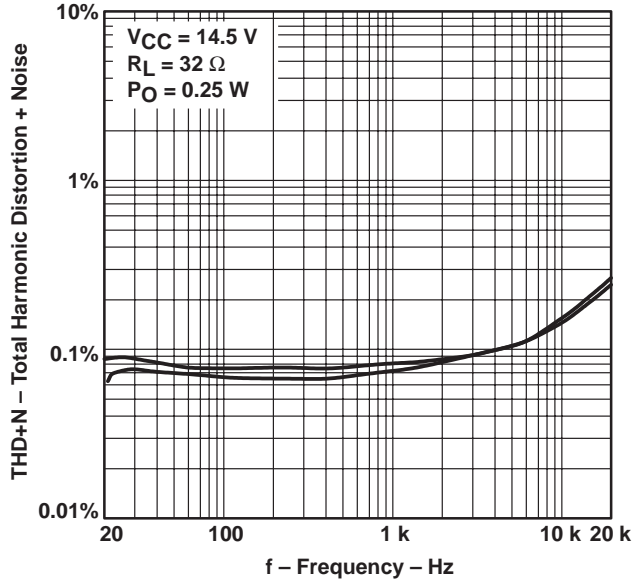

Figure 9

TOTAL HARMONIC DISTORTION PLUS NOISE
vs
POWER OUTPUT

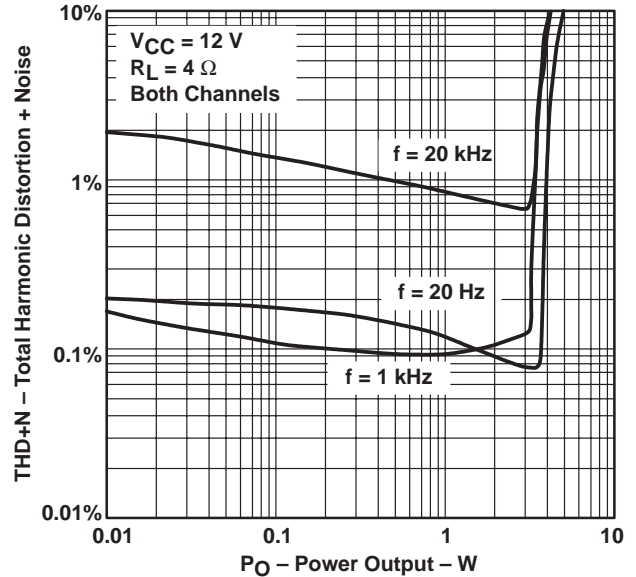

Figure 10

TOTAL HARMONIC DISTORTION PLUS NOISE
vs
POWER OUTPUT

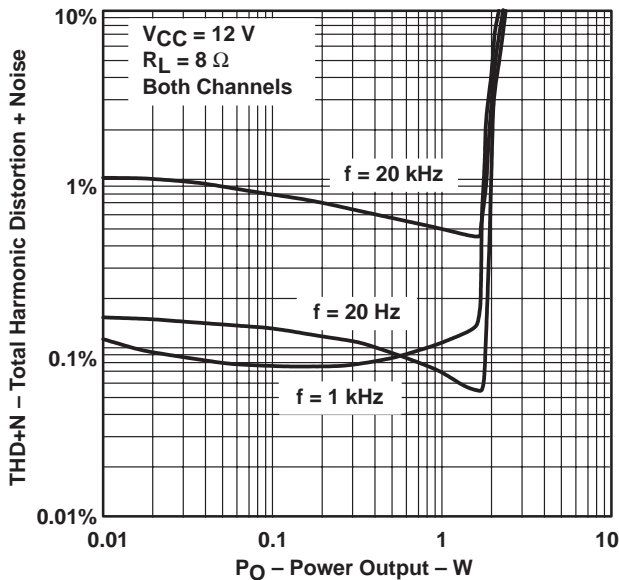

Figure 11

TOTAL HARMONIC DISTORTION PLUS NOISE
vs
POWER OUTPUT

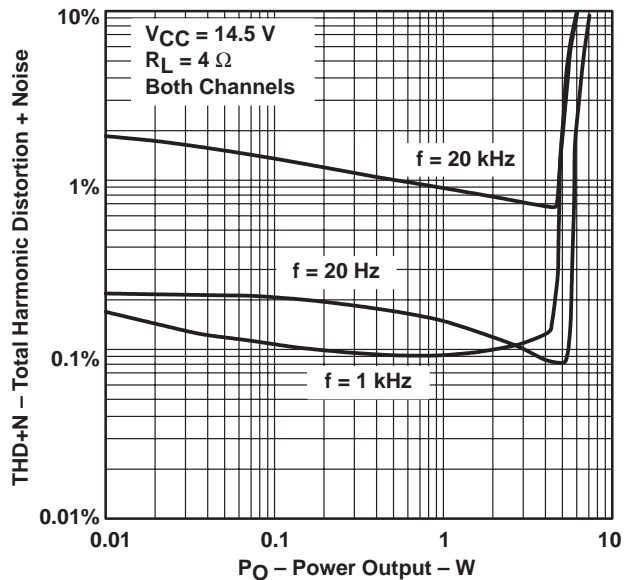

Figure 12

TPA1517 6-W STEREO AUDIO POWER AMPLIFIER

SLOS162B – MARCH 1997 – REVISED MARCH 2000

TYPICAL CHARACTERISTICS

**TOTAL HARMONIC DISTORTION PLUS NOISE
vs
POWER OUTPUT**

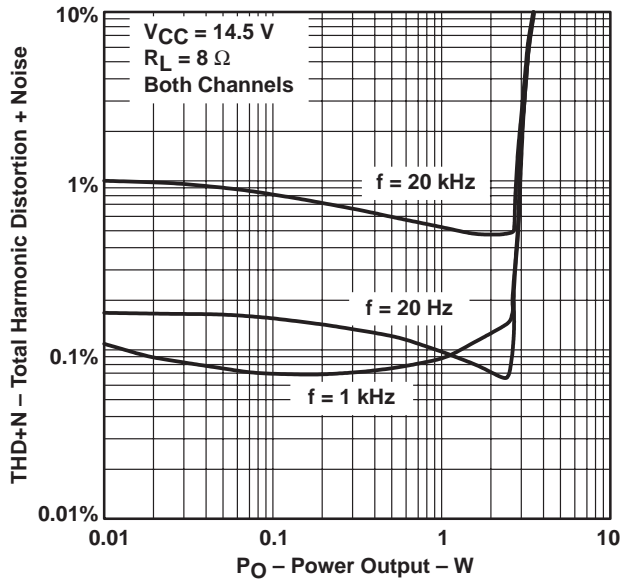

Figure 13

**CROSSTALK
vs
FREQUENCY**

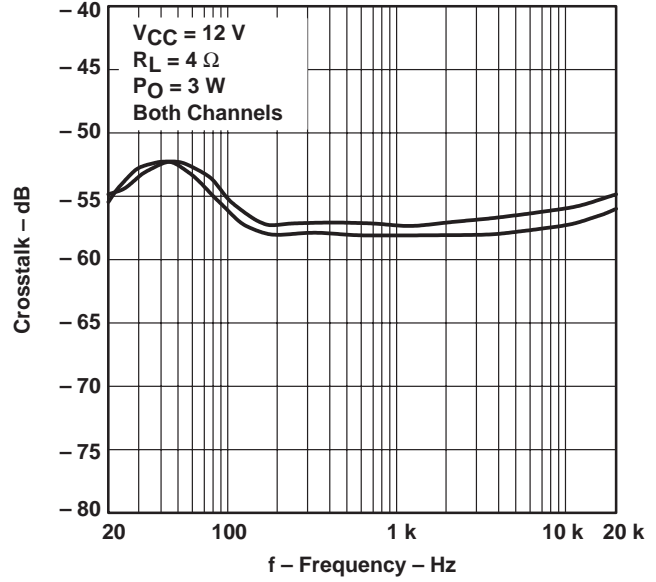

Figure 14

**CROSSTALK
vs
FREQUENCY**

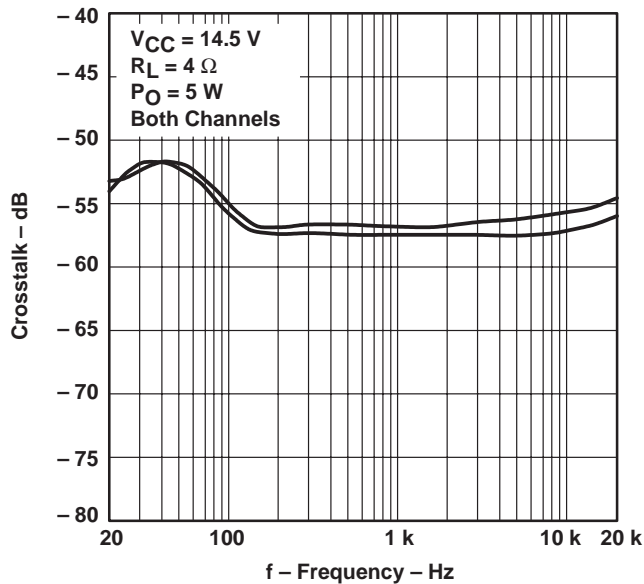

Figure 15



TYPICAL CHARACTERISTICS

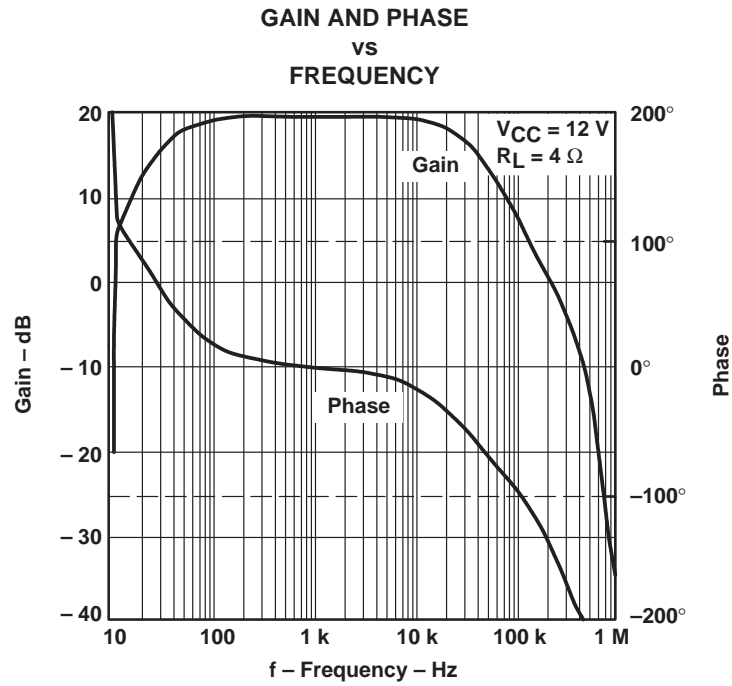

Figure 16

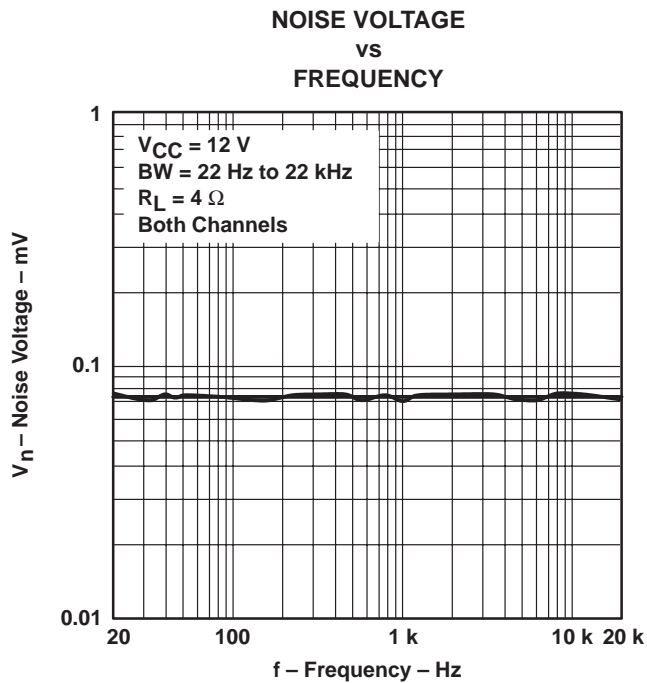

Figure 17

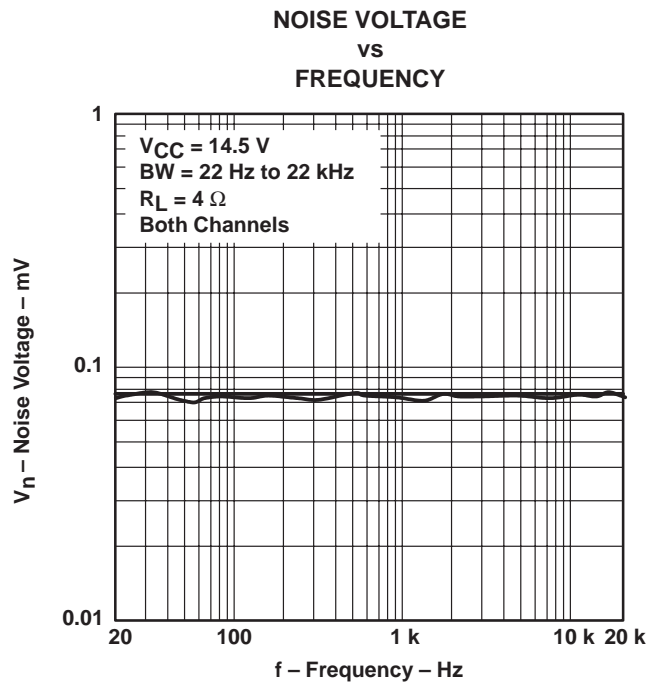

Figure 18

TPA1517 6-W STEREO AUDIO POWER AMPLIFIER

SLOS162B – MARCH 1997 – REVISED MARCH 2000

TYPICAL CHARACTERISTICS

OUTPUT POWER
vs
SUPPLY VOLTAGE

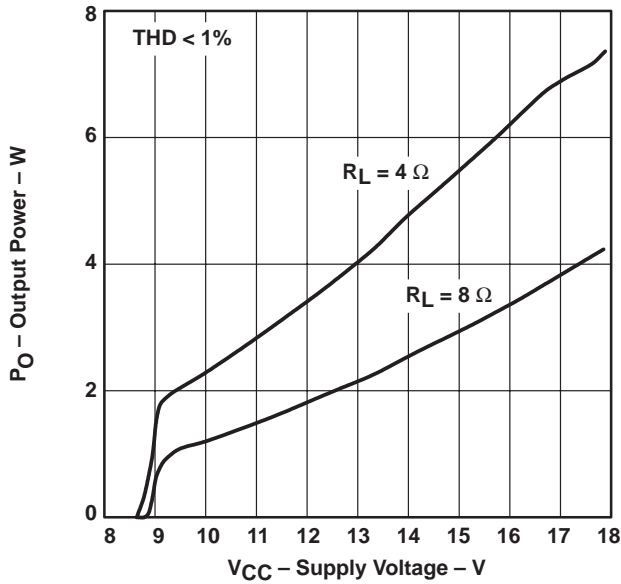

Figure 19

OUTPUT POWER
vs
LOAD RESISTANCE

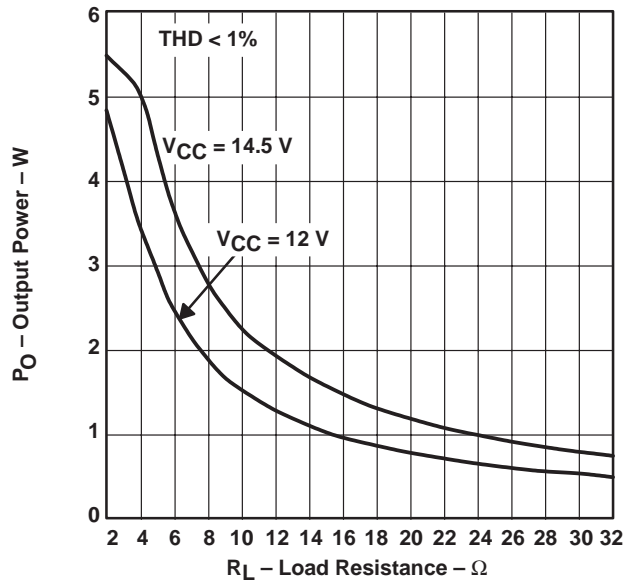

Figure 20

POWER DISSIPATION
vs
OUTPUT POWER

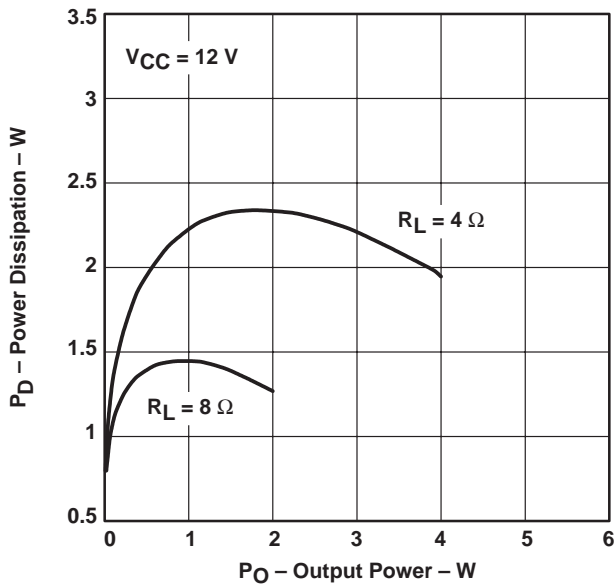

Figure 21

POWER DISSIPATION
vs
OUTPUT POWER

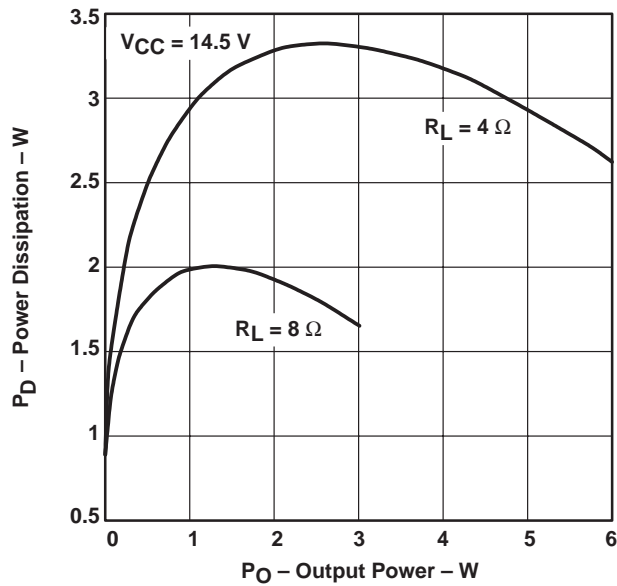
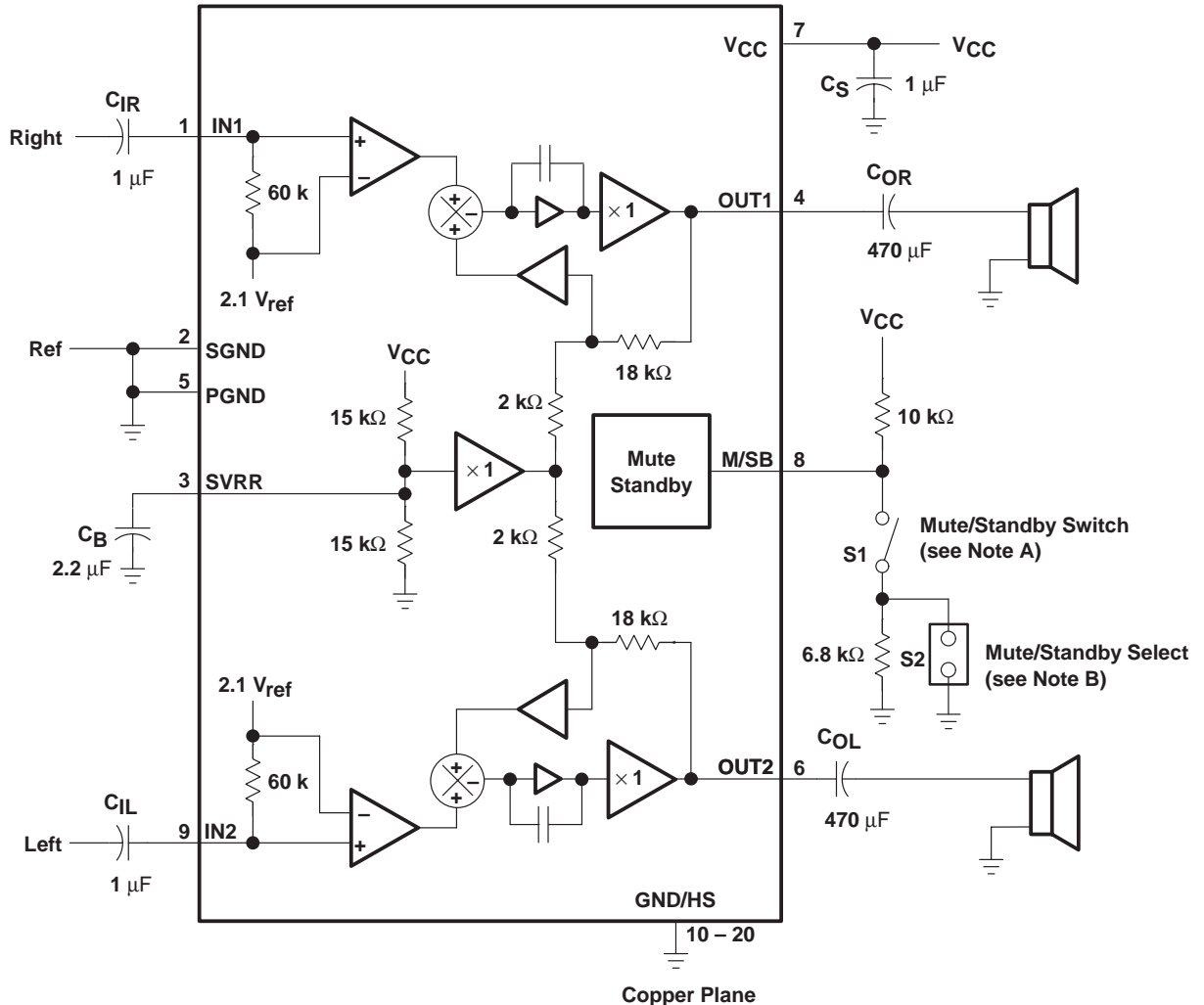

Figure 22

APPLICATION INFORMATION

amplifier operation

The TPA1517 is a stereo audio power amplifier designed to drive 4-Ω speakers at up to 6 W per channel. Figure 23 is a schematic diagram of the minimum recommended configuration of the amplifier. Gain is internally fixed at 20 dB (gain of 10 V/V).



- NOTES: A. When S1 is open, the TPA1517 operates normally. When this switch is closed, the device is in mute/standby mode.
 B. When S2 is open, activating S1 places the TPA1517 in mute mode. When S2 is closed, activating S1 places the TPA1517 in standby mode.
 C. The terminal numbers are for the 20-pin NE package.

Figure 23. TPA1517 Minimum Configuration

The following equation is used to relate gain in V/V to dB:

$$G_{dB} = 20 \text{ LOG}(G_{V/V})$$

TPA1517

6-W STEREO AUDIO POWER AMPLIFIER

SLOS162B – MARCH 1997 – REVISED MARCH 2000

APPLICATION INFORMATION

The audio outputs are biased to a midrail voltage which is shown by the following equation:

$$V_{MID} = \frac{V_{CC}}{2}$$

The audio inputs are always biased to 2.1 V when in mute or normal mode. Any dc offset between the input signal source and the input terminal is amplified and can seriously degrade the performance of the amplifier. For this reason, it is recommended that the inputs always be connected through a series capacitor (ac coupled). The power outputs, also having a dc bias, must be connected to the speakers via series capacitors.

mute/standby operation

The TPA1517 has three modes of operation; normal, mute, and standby. They are controlled by the voltage on the M/SB terminal as described in Figure 24. In normal mode, the TPA1517 amplifies the signal applied to the two input terminals providing low impedance drive to speakers connected to the output terminals. In mute mode, the amplifier retains all bias voltages and quiescent supply current levels but does not pass the input signal to the output. In standby mode, the internal bias generators and power-drive stages are turned off, thereby reducing the supply current levels.

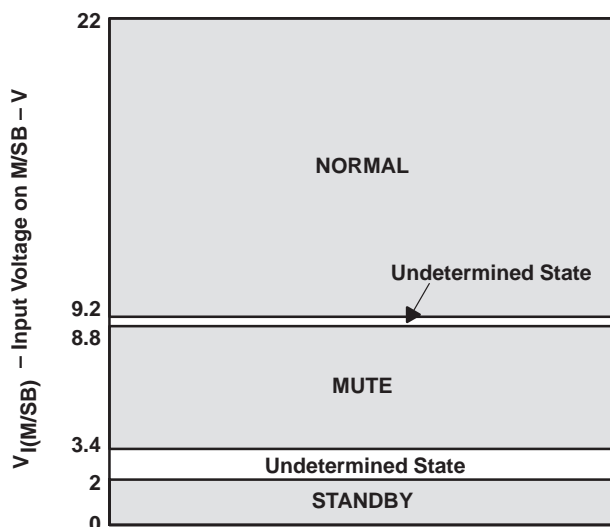
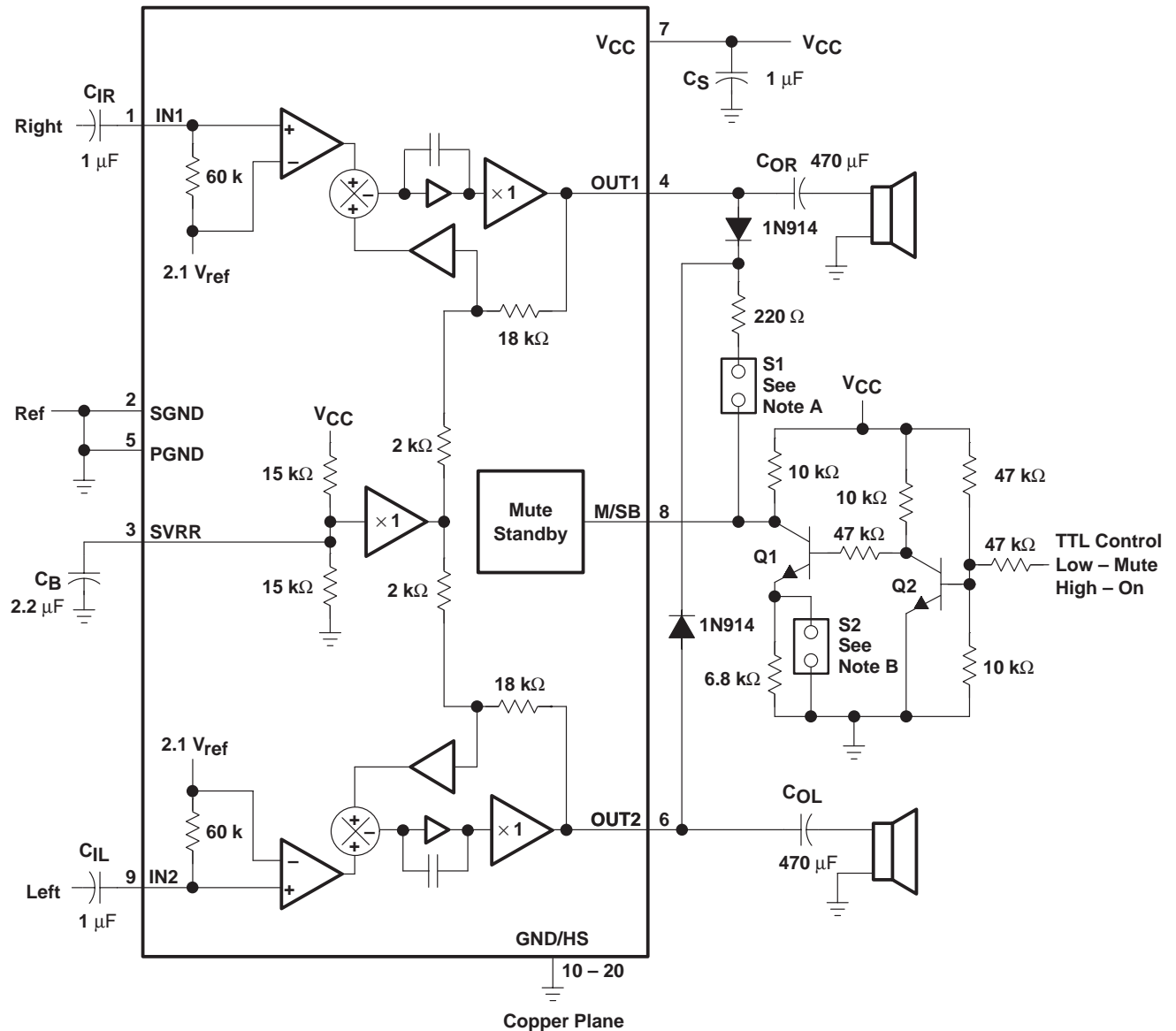

Figure 24. Standby, Mute, and Normal (On) Operating Conditions

The designer must take care to place the control voltages within the defined ranges for each desired mode, whenever an external circuit is used to control the input voltage at the M/SB terminal. The undefined area can cause unpredictable performance and should be avoided. As the control voltage moves through the undefined areas pop or click sounds may be heard in the speaker. Moving from mute to normal causes a very small click sound. Whereas moving from standby to mute can cause a much larger pop sound. Figure 25 shows external circuitry designed to help reduce transition pops when moving from standby mode to normal mode.

APPLICATION INFORMATION

Figure 25 is a reference schematic that provides TTL-level control of the M/SB terminal. A diode network is also included which helps reduce turn-on pop noises. The diodes serve to drain the charge out of the output coupling capacitors while the amplifier is in shutdown mode. When the M/SB voltage is in the normal operating range, the diodes have no effect on the ac performance of the system.



- NOTES: A. When S1 is closed, the depop circuitry is active during standby mode.
 B. When S2 is open, activating S1 places the TPA1517 in mute mode. When S2 is closed, activating S1 places the TPA1517 in standby mode.
 C. The terminal numbers are for the 20-pin NE package.

Figure 25. TTL Control with POP Reduction

TPA1517

6-W STEREO AUDIO POWER AMPLIFIER

SLOS162B – MARCH 1997 – REVISED MARCH 2000

APPLICATION INFORMATION

component selection

Some of the general concerns for selection of capacitors are:

- Leakage currents on aluminum electrolytic capacitors
- ESR (equivalent series resistance)
- Temperature ratings

leakage currents

Leakage currents on most ceramic, polystyrene, and paper capacitors are negligible for this application. Leakage currents for aluminum electrolytic and tantalum tend to be higher. This is especially important on the input terminals and the SVRR capacitor. These nodes encounter from 3 V to 7 V, and need to have leakage currents less than 1 μ A to keep from affecting the output power and noise performance.

equivalent series resistance

ESR is mainly important on the output coupling capacitor, where even 1 Ω of ESR in C_O with an 8- Ω speaker can reduce the output drive power by 12.5%. ESR should be considered across the frequency range of interest, (i.e., 20 Hz to 20 kHz). The following equation calculates the amount of power lost in the coupling capacitor:

$$\% \text{ Power in } C_O = \frac{\text{ESR}}{R_L}$$

In general, the power supply decoupling requires a very low ESR as well to take advantage of the full output drive current.

temperature range

The temperature range of the capacitors may or may not seem like an obvious thing to specify, but it is very important. Many of the high-density capacitors perform very differently at different temperatures. When consistent high performance is required from the system over temperature in terms of low THD, maximum output power, and turn-on/off popping, then interactions of the coupling capacitors and the SVRR capacitors need to be considered, as well as the change in ESR on the output capacitor with temperature.

turn-on pop consideration

To select the proper input coupling capacitor, the designer should select a capacitor large enough to allow the lowest desired frequency pass and small enough that the time constant is shorter than the output RC time constant to minimize turn-on popping. The input time constant for the TPA1517 is determined by the input 60-k Ω resistance of the amplifier, and the input coupling capacitor according to the following generic equation:

$$T_C = \frac{1}{2\pi RC}$$

For example, 8- Ω speakers and 220- μ F output coupling capacitors would yield a 90-Hz cut-off point for the output RC network. The input network should be the same speed or faster (> 90 Hz T_C). A good choice would be 180 Hz. As the input resistance is 60 k Ω , a 14-nF input coupling capacitor would do.

The bypass-capacitor time constant should be much larger ($\times 5$) than either the input coupling capacitor time constant or the output coupling capacitor time constants. In the previous example with the 220- μ F output coupling capacitor, the designer should want the bypass capacitor, T_C , to be in the order of 18 Hz or lower. To get an 18-Hz time constant, C_B is required to be 1 μ F or larger because the resistance this capacitor sees is 7.5 k Ω .



POST OFFICE BOX 655303 • DALLAS, TEXAS 75265

APPLICATION INFORMATION

In summary, follow one of the three simple relations presented below, depending on the tradeoffs between low frequency response and turn-on pop. If depop performance is the top priority, then follow:

$$7500 C_B > 5R_L C_O > 300000 C_I$$

If low frequency ac response is more important but depop is still a consideration then follow:

$$\frac{1}{2\pi 60000 C_I} < 10 \text{ Hz}$$

Finally, if low frequency response is most important and depop is not a consideration then follow:

$$\frac{1}{2\pi 60000 C_I} \leq \frac{1}{2\pi R_L C_I} \leq f_{low}$$

thermal applications

Linear power amplifiers dissipate a significant amount of heat in the package under normal operating conditions. A typical music CD requires 12 dB to 15 dB of dynamic headroom to pass the loudest portions without distortion as compared with the average power output. Figure 19 shows that when the TPA1517 is operating from a 12-V supply into a 4-Ω speaker that approximately 3.5 W peaks are possible. Converting watts to dB using the following equation:

$$\begin{aligned} P_{dB} &= 10 \text{Log} \left(\frac{P_W}{P_{ref}} \right) \\ &= 10 \text{Log} \left(\frac{3.5}{1} \right) \\ &= 5.44 \text{ dB} \end{aligned}$$

Subtracting dB for the headroom restriction to obtain the average listening level without distortion yields the following:

$$5.44 \text{ dB} - 15 \text{ dB} = -9.56 \text{ dB (15 dB headroom)}$$

$$5.44 \text{ dB} - 12 \text{ dB} = -6.56 \text{ dB (12 dB headroom)}$$

Converting dB back into watts:

$$\begin{aligned} P_W &= 10^{P_{dB}/10} \times P_{ref} \\ &= 111 \text{ mW (15 dB headroom)} \\ &= 221 \text{ mW (12 dB headroom)} \end{aligned}$$

This is valuable information to consider when attempting to estimate the heat dissipation requirements for the amplifier system. Comparing the absolute worst cast, which is 3.5 W of continuous power output with 0 dB of headroom, against 12-dB and 15-dB applications drastically affects maximum ambient temperature ratings for the system. Using the power dissipation curves for a 12-V, 4-Ω system, internal dissipation in the TPA1517 and maximum ambient temperatures are shown in Table 1.

TPA1517

6-W STEREO AUDIO POWER AMPLIFIER

SLOS162B – MARCH 1997 – REVISED MARCH 2000

APPLICATION INFORMATION

Table 1. TPA1517 Power Rating

PEAK OUTPUT POWER (W)	AVERAGE OUTPUT POWER	POWER DISSIPATION (W/Channel)	MAXIMUM AMBIENT TEMPERATURE
3.5	3.5 W	2.1	-34°C
3.5	1.77 W (3 dB)	2.4	-61°C
3.5	884 mW (6 dB)	2.25	-48°C
3.5	442 mW (9 dB)	1.75	-4°C
3.5	221 mW (12 dB)	1.5	18°C
3.5	111 mW (15 dB)	1.25	40°C

The maximum ambient temperature depends on the heatsinking ability of the PCB system. Using the derating factor for the NE package with 4 square inches of copper area is 22.8 mW/°C and 38.8 mW/°C respectively. Converting this to θ_{JA} :

$$\theta_{JA} = \frac{1}{\text{Derating}}$$

$$\begin{aligned} \text{For 0 CFM : } &= \frac{1}{0.0228} \\ &= 43.9^\circ\text{C/W} \end{aligned}$$

To calculate maximum ambient temperatures, first consider that the numbers from the dissipation graphs are per channel so the dissipated heat needs to be doubled for two channel operation. Given θ_{JA} , the maximum allowable junction temperature and the total internal dissipation, the maximum ambient temperature can be calculated with the following equation. The maximum recommended junction temperature for the TPA1517 is 150°C.

$$\begin{aligned} T_A \text{ Max} &= T_J \text{ Max} - \theta_{JA} P_D \\ &= 150 - 43.9(1.25 \times 2) = 40^\circ\text{C (15 dB headroom, 0 CFM)} \end{aligned}$$

Table 1 clearly shows that for most applications some airflow is required to keep junction temperatures in the specified range. The TPA1517 is designed with thermal protection that turns the device off when the junction temperature surpasses 150°C to prevent damage to the IC. Using the DWP package on a multilayer PCB with internal ground planes can achieve better thermal performance. Table 1 was calculated for a maximum volume system; when the output level is reduced, the numbers in the table change significantly. Also using 8-Ω speakers dramatically increases the thermal performance by increasing amplifier efficiency.



APPLICATION INFORMATION

TPA1517 NE THERMAL RESISTANCE, θ_{JA}
VS
COPPER AREA

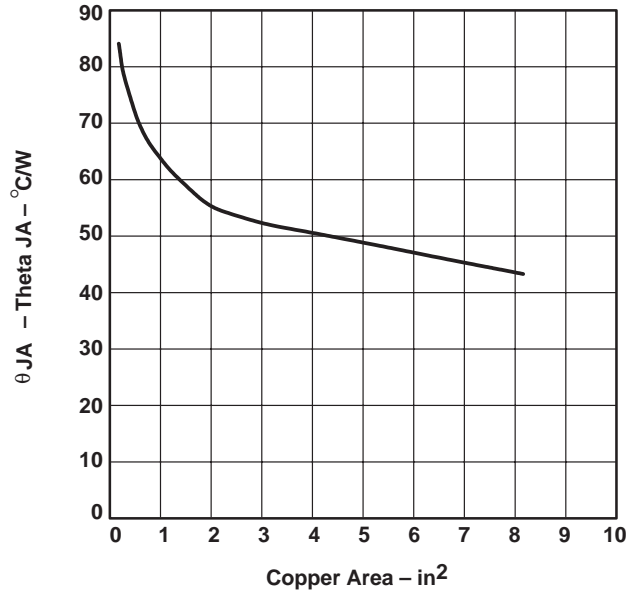

Figure 26

TPA1517 6-W STEREO AUDIO POWER AMPLIFIER

SLOS162B – MARCH 1997 – REVISED MARCH 2000

MECHANICAL INFORMATION

DWP (R-PDSO-G20)

PowerPAD™ PLASTIC SMALL-OUTLINE PACKAGE

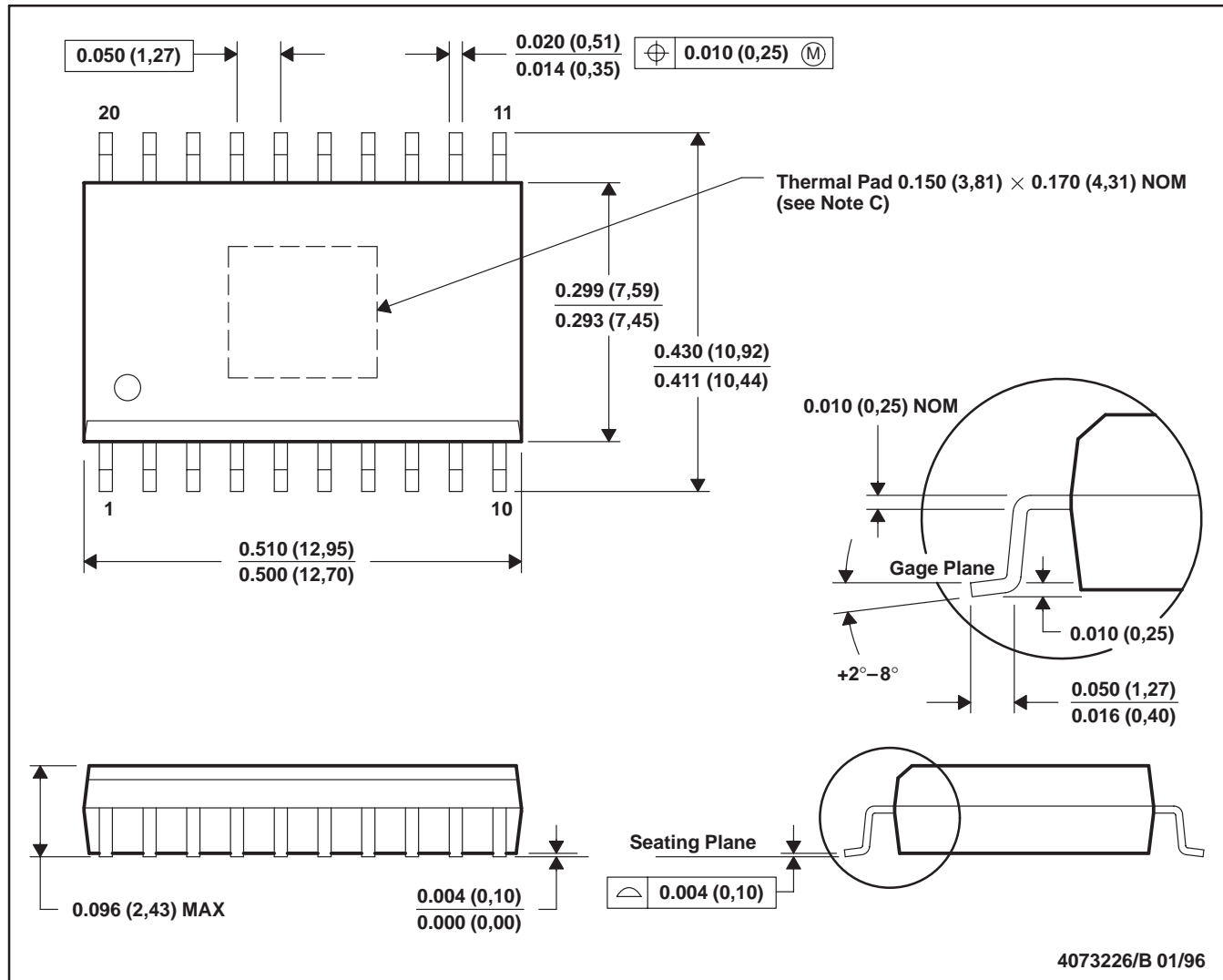

- NOTES: A. All linear dimensions are in inches (millimeters).
 B. This drawing is subject to change without notice.
 C. The thermal performance may be enhanced by bonding the thermal pad to an external thermal plane. This solderable pad is electrically and thermally connected to the backside of the die and leads 1, 10, 11 and 20.

PowerPAD is a trademark of Texas Instruments Incorporated.



POST OFFICE BOX 655303 • DALLAS, TEXAS 75265

MECHANICAL INFORMATION

NE (R-PDIP-T**)

PLASTIC DUAL-IN-LINE PACKAGE

20 PIN SHOWN

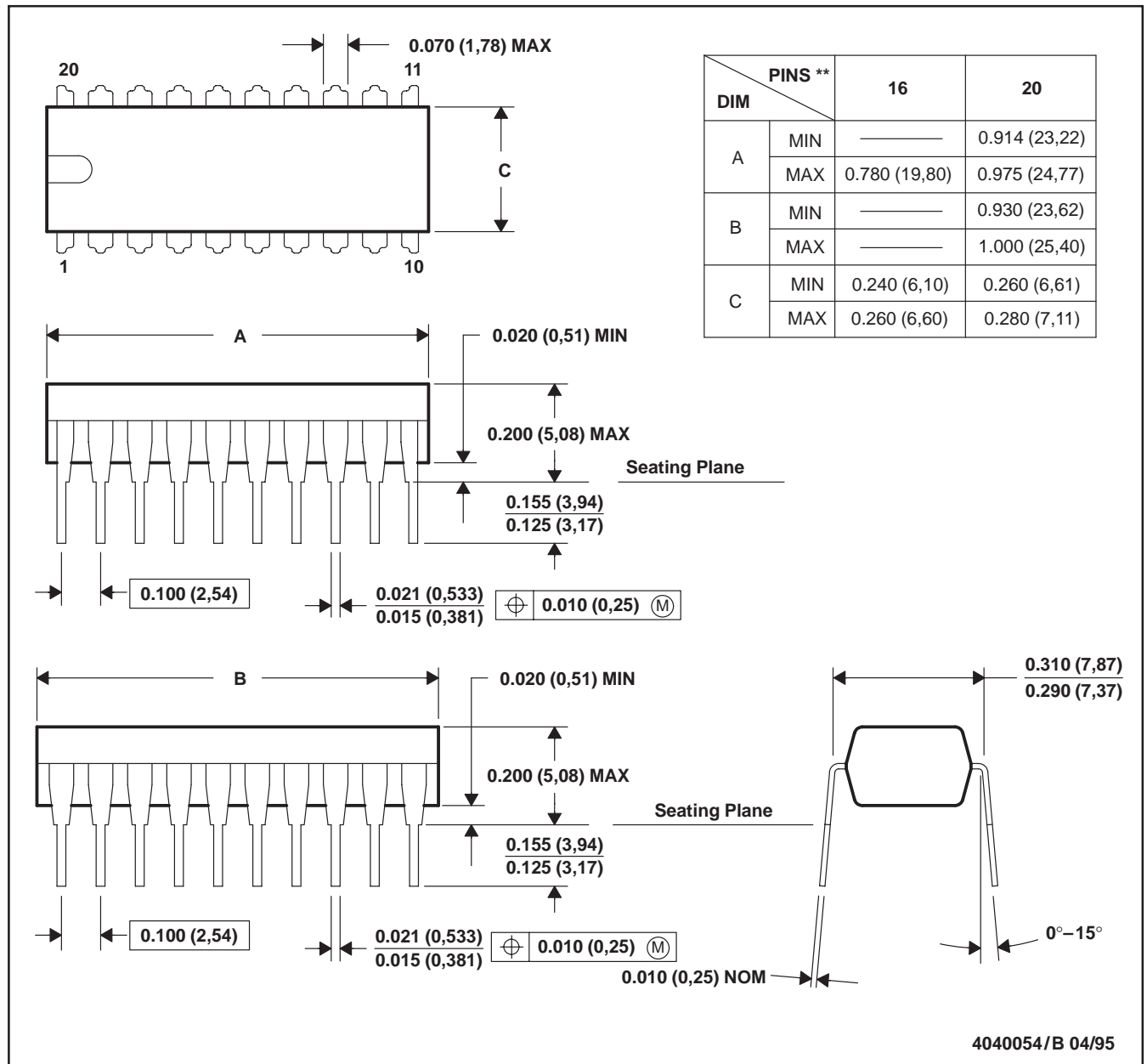

- NOTES: A. All linear dimensions are in inches (millimeters).
 B. This drawing is subject to change without notice.
 C. Falls within JEDEC MS-001 (16 pin only)

IMPORTANT NOTICE

Texas Instruments and its subsidiaries (TI) reserve the right to make changes to their products or to discontinue any product or service without notice, and advise customers to obtain the latest version of relevant information to verify, before placing orders, that information being relied on is current and complete. All products are sold subject to the terms and conditions of sale supplied at the time of order acknowledgement, including those pertaining to warranty, patent infringement, and limitation of liability.

TI warrants performance of its semiconductor products to the specifications applicable at the time of sale in accordance with TI's standard warranty. Testing and other quality control techniques are utilized to the extent TI deems necessary to support this warranty. Specific testing of all parameters of each device is not necessarily performed, except those mandated by government requirements.

CERTAIN APPLICATIONS USING SEMICONDUCTOR PRODUCTS MAY INVOLVE POTENTIAL RISKS OF DEATH, PERSONAL INJURY, OR SEVERE PROPERTY OR ENVIRONMENTAL DAMAGE ("CRITICAL APPLICATIONS"). TI SEMICONDUCTOR PRODUCTS ARE NOT DESIGNED, AUTHORIZED, OR WARRANTED TO BE SUITABLE FOR USE IN LIFE-SUPPORT DEVICES OR SYSTEMS OR OTHER CRITICAL APPLICATIONS. INCLUSION OF TI PRODUCTS IN SUCH APPLICATIONS IS UNDERSTOOD TO BE FULLY AT THE CUSTOMER'S RISK.

In order to minimize risks associated with the customer's applications, adequate design and operating safeguards must be provided by the customer to minimize inherent or procedural hazards.

TI assumes no liability for applications assistance or customer product design. TI does not warrant or represent that any license, either express or implied, is granted under any patent right, copyright, mask work right, or other intellectual property right of TI covering or relating to any combination, machine, or process in which such semiconductor products or services might be or are used. TI's publication of information regarding any third party's products or services does not constitute TI's approval, warranty or endorsement thereof.