

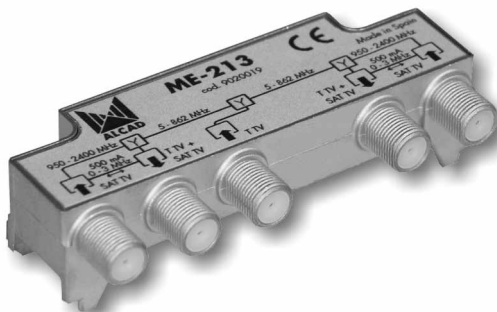

MEZCLADORES TV-SAT
TTV-SAT MULTIPLEXERS
COUPLEURS TVT-SAT



SERIE 902 SERIES

CÓDIGO-CODE-CODE		9020045	
MODELO-MODEL-MODELE		MM-214	
Conector Connector Connecteur		F	
Número de entradas Number of inputs Nombre d'entrées		2	
Rango de frecuencia Frequency range Gamme de frequences	Band	FM/TV	SAT
	MHz	5 - 862	950 -2400
Atenuación de inserción Insertion loss Attenuation d'insertion	dB	1±0,5	1±0,5
Rechazo entre entradas Rejection between inputs Rejection entre entrées	dB	≥ 35	
Paso de corriente Dc path Passage d'alimentation	mA	-	0 - 500
	MHz	-	0 - 3
Paso 22 KHz/DiSEqC Pass 22 KHz/DiSEqC Passage 22 KHz/DiSEqC		-	•
Temperatura de funcionamiento Operating temperature Temperature de fonctionnement	°C	-10 .. +65	
Índice de protección Protection index Indice de protection		IP 53	

MM-214

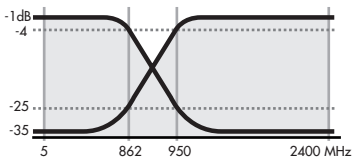
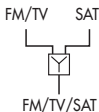

CÓDIGO-CODE-CODE		9020015		9020019		
MODELO-MODEL-MODELE		ME-214		ME-213		
Conector Connector Connecteur		F				
Número de entradas Number of inputs Nombre d'entrées		2		3		
Rango de frecuencia Frequency range Gamme de frequences	Band	FM/TV	SAT	FM/TV	SAT1	SAT2
	MHz	5 - 862	930 -2400	5 - 862	950-2400	950-2400
Atenuación de inserción Insertion loss Attenuation d'insertion	dB	1±0,5	1±0,5	4±1,0	1±0,5	1±0,5
Rechazo entre entradas Rejection between inputs Rejection entre entrées	dB	≥ 35				
Paso de corriente Dc path Passage d'alimentation	mA	-	0 - 500	-	0 - 500	0 - 500
	MHz	-	0 - 3	-	0 - 3	0 - 3
Paso 22 KHz/DiSEqC Pass 22 KHz/DiSEqC Passage 22 KHz/DiSEqC		-	●	-	●	●
Temperatura de funcionamiento Operating temperature Temperature de fonctionnement	°C	-10 .. +65				
Índice de protección Protection index Indice de protection		IP 53				

ME-214

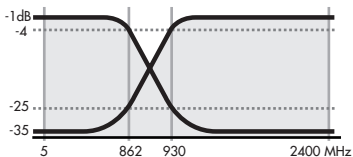
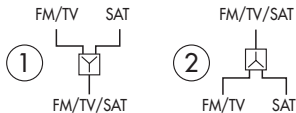

ME-213

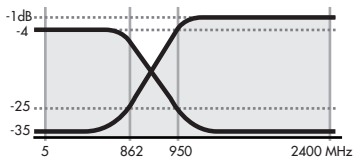
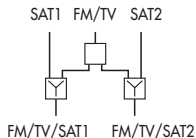

ESQUEMAS TÍPICOS
 CONNECTION DIAGRAMS
 SCHEMAS DE CONNEXION

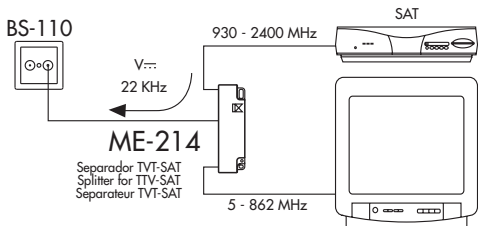
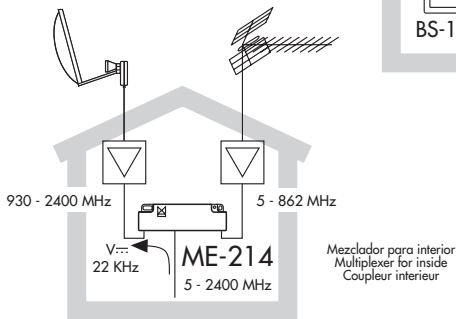
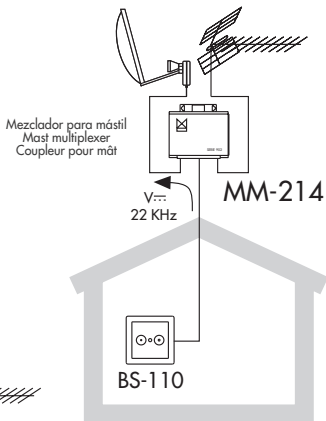

ESQUEMA TÍPICO
CONNECTION DIAGRAMS
SCHEMAS DE CONNEXION

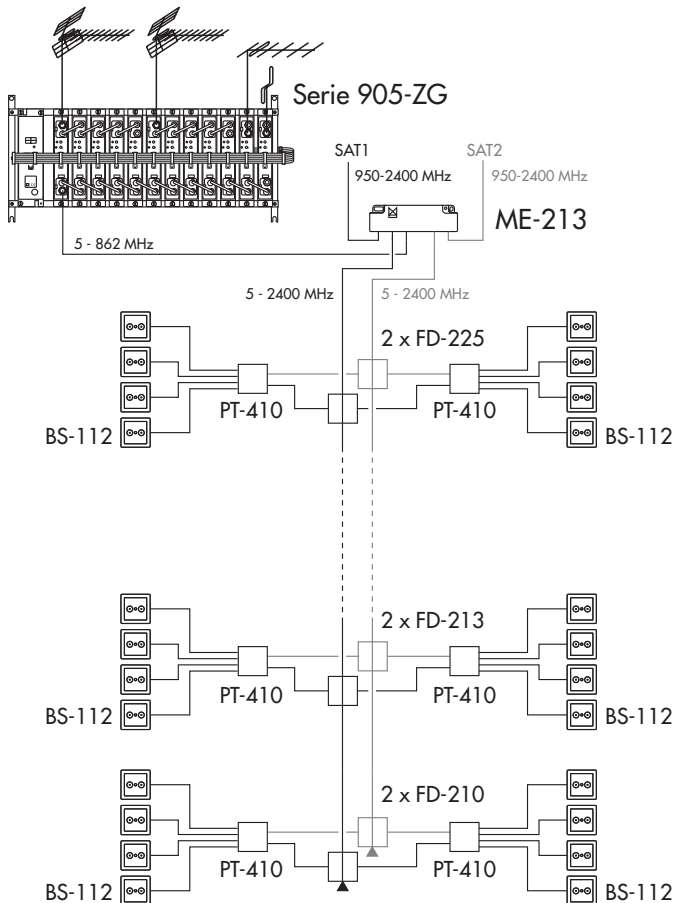



DECLARATION OF CONFORMITY

according to EN ISO/IEC 17050-1:2004

Manufacturer's Name: ALCAD, S.A.
Manufacturer's Address: Pol. Ind. Arreche-Ugalde, 1
Apdo. 455
20305 IRUN (Guipúzcoa)
SPAIN

declares that the product
Product Name: 902 Series: TTV-SAT MULTIPLEXERS
Model Number(s): ME-213, ME-214, MM-214

Product Option(s): INCLUDING ALL OPTIONS

is in conformity with:

Safety: EN 50083-1:1993

EMC: EN 50083-2:2001

EN 61000-6-1:2001

EN 61000-4-2:1995 ESD 15KV AD, 8KV CD.

EN 61000-4-4:1995 EFT 4KV-2,5KHz Sig. Lines.

Technical Features : EN50083-4:1998

Supplementary Information:

The product herewith complies with the requirements of the Low Voltage Directive 73/23/ECC and the EMC Directive 89/336/EEC and their relevant amendments, gathered under the directives 93/68/EEC.

Note: to comply with these directives, do not use the products without covers and operate the system as specified.



Irún,

01-08-05

Date

Anton Galarza / General Manager

Especificaciones sujetas a modificación sin previo aviso
Specifications subject to modifications without prior notice
Les spécifications sont soumises à de possible modifications sans avis préalable



ALCAD, S.A.
Tel. 943 63 96 60
Fax 943 63 92 66
Int. Tel. +34 - 943 63 96 60
info@alcad.net
Apdo. 455 - Pol. Ind. Arreche-Ugalde, 1
20305 IRUN - Spain

www.alcad.net

FRANCE - Hendaye
Tel. 00 34 - 943 63 96 60

GERMANY - Munich
Tel. 089 55 26 48

CZECH REPUBLIC - Ostrovačice
Tel. 546 427 063

UNITED ARAB EMIRATES - Dubai
Tel. 971 4 887 19 50

POLAND - Cieszyn
Tel. 033 851 0821



ISO 9001

